



Bundesstelle für Seeunfalluntersuchung
Federal Bureau of Maritime Casualty Investigation
Federal Higher Authority subordinated to the Ministry
of Transport and Digital Infrastructure

Investigation Report 52/18

Serious Marine Casualty

**Allision of the container ship AKACIA
with a lock gate on the Kiel Canal in Kiel-Holtenau
on 19 February 2018**

18 December 2019

This investigation was conducted in conformity with the Act to improve safety of shipping by investigating marine casualties and other incidents (Maritime Safety Investigation Act – SUG). According to said Act, the sole objective of this investigation is to prevent future accidents. This investigation does not serve to ascertain fault, liability or claims (Article 9(2) SUG).

This report should not be used in court proceedings or proceedings of the Maritime Board. Reference is made to Article 34(4) SUG.

The German text shall prevail in the interpretation of this investigation report.

Issued by:
Bundesstelle für Seeunfalluntersuchung – BSU
(Federal Bureau of Maritime Casualty Investigation)
Bernhard-Nocht-Str. 78
D-20359 Hamburg



Director: Ulf Kaspera
Phone: +49 40 3190 8300
posteingang-bsu@bsh.de

Fax: +49 40 3190 8340
www.bsu-bund.de

Table of Contents

1	SUMMARY.....	8
2	FACTUAL INFORMATION.....	9
2.1	Photograph of the ship	9
2.2	Ship particulars.....	9
2.3	Voyage particulars.....	10
2.4	Marine casualty or incident information	10
2.5	Shore authority involvement and emergency response.....	11
3	COURSE OF THE ACCIDENT AND INVESTIGATION	12
3.1	Course of the accident	12
3.1.1	Course of the voyage	12
3.1.2	Additional measures.....	16
3.2	Investigation	16
3.2.1	AKACIA	17
3.2.2	Manning	18
3.2.3	VDR and other technical recordings.....	18
3.2.3.1	VDR.....	19
3.2.4	CPP system.....	30
3.2.4.1	Description of the CPP system.....	30
3.2.4.2	Hydraulic power unit.....	32
3.2.4.3	OD-box.....	34
3.2.4.4	Propeller shaft	34
3.2.4.5	Propeller hub	34
3.2.4.6	Overview of the hydraulic system for adjusting the blades.....	35
3.2.4.7	Control options for the CPP system	37
3.2.5	Examination of the CPP system	40
3.2.5.1	Determination of the different system times	40
3.2.5.2	CPP system error messages.....	41
3.2.5.3	Other findings on the hydraulic system	43
3.2.5.4	Damage to the propeller blades	45
3.2.5.5	Findings on the functioning of the CPP system	47
3.2.5.6	Findings on the propeller hub and hydraulic system	48
3.2.5.7	Proportional valve.....	57
3.2.5.8	Shell-and-tube cooler for hydraulic oil	58
3.2.6	Engine alarm printer	59
3.2.6.1	Statements of the engine room crew.....	62
3.2.7	Emergency anchoring manoeuvre.....	62
4	ANALYSIS.....	64
4.1	Failure of the CPP system.....	64
4.2	Course of the voyage	68
4.3	Chronological overview of the error messages and alarms.....	71
4.3.1	Manoeuvring characteristics.....	72

5	CONCLUSIONS.....	74
5.1	CPP system.....	74
5.2	Course of the voyage	74
5.3	Times	75
6	ACTION TAKEN.....	76
7	SOURCES	77

Table of Figures

Figure 1: Photograph of the AKACIA.....	9
Figure 2: Navigational chart showing the scene of the accident.....	10
Figure 3: CPP system control panel.....	14
Figure 4: The AKACIA and the damaged lock gate.....	16
Figure 5: View ahead from the AKACIA's bridge.....	17
Figure 6: Radar image at 234316.....	20
Figure 7: Radar image at 234729.....	21
Figure 8: Radar image at 234814.....	22
Figure 9: Radar image at 234844.....	22
Figure 10: Radar image at 234913; "Pitch is working.".....	23
Figure 11: Screenshot of the replayer at 235013.....	23
Figure 12: Radar image at 235043.....	24
Figure 13: Radar image at 235058.....	25
Figure 14: Radar image at 235127.....	25
Figure 15: Radar image at 235157.....	26
Figure 16: Radar image at 235212.....	27
Figure 17: Radar image at 235227.....	27
Figure 18: Radar image at 235312.....	28
Figure 19: Radar image at 235342.....	29
Figure 20: Radar image at 235356; "Emergency stop.".....	29
Figure 21: Radar image at 235411.....	30
Figure 22: Design of the propulsion system.....	31
Figure 23: Diagram of a SCHOTTEL SCP_XG system.....	32
Figure 24: Side view of the proportional valve.....	33
Figure 25: Hydraulic power unit.....	34
Figure 26: Propeller hub.....	35
Figure 27: Schematic drawing of the hydraulic system.....	36
Figure 28: CPP system's control panel in engine room.....	37
Figure 29: Detail of the CPP system's control panel at the bridge.....	39

Figure 30: 4/3-way proportional valve and manual operation	40
Figure 31: First alarm associated with the accident.....	41
Figure 32: Extract from the printout of the alarm printer in the ECR.....	41
Figure 33: CPP system (meaning of error 00093)	42
Figure 34: Extract from the CPP system's alarm log	42
Figure 35: CPP system (meaning of error 00094)	42
Figure 36: Damage to one of the propeller blades.....	45
Figure 37: Close-up of the damage	45
Figure 38: Crack in one of the propeller blades	46
Figure 39: More damage on another blade	47
Figure 40: Propeller hub	48
Figure 41: Location of the fragments shown in Figure 42.....	49
Figure 42: Fragments of the support plate found.....	49
Figure 43: Deposits in the tank of the hydraulic power unit	50
Figure 44: Sample of particles found in the tank.....	50
Figure 45: Valve body and removed foreign body (A)	52
Figure 46: Valve body belonging to the hydraulic cylinder in the propeller hub	53
Figure 47: Removed foreign bodies.....	53
Figure 48: Torn seal ring with notches.....	54
Figure 49: Non-return valve with foreign body (B)	54
Figure 50: Non-return valve and removed foreign body	55
Figure 51: Extract from the diagram of the hydraulic system (see Figure 27)	55
Figure 52: Material removal on cover flange.....	56
Figure 53: Notch on the bearing plate	56
Figure 54: Damage to the control edge of the piston.....	57
Figure 55: Damage to the piston of the proportional valve	58
Figure 56: View into the shell-and-tube cooler.....	59
Figure 57: Identified foreign body	59
Figure 58: Extract from the printout of the ECR's alarm printer	61
Figure 59: Hydraulic oil pipe with support plate and circlip	64
Figure 60: 4/3-way proportional valve.....	66
Figure 61: 4/3-way proportional valve.....	66
Figure 62: Overview of error messages and alarms	71

Figure 63: Speed-time-diagram for AHEAD FULL SEA to ASTERN FULL 72
Figure 64: Data for AHEAD FULL SEA to ASTERN FULL 72
Figure 65: Speed-time-diagram for AHEAD FULL SEA to STOP 73
Figure 66: Data for AHEAD FULL SEA to STOP 73

1 SUMMARY

On 19 February 2018, the full container ship AKACIA, sailing under the flag of Portugal, was en route from Bremerhaven to St. Petersburg. The ship was scheduled to enter the Neue Südschleuse lock at around midnight after she had transited the Kiel Canal (NOK¹). The bridge was sufficiently manned for this manoeuvre. A pilot was advising the master. A canal helmsman steered the ship. Both manoeuvring stations had been manned for the entry into the lock.

After the prescribed astern manoeuvre using the controllable pitch propeller (CPP) system, the AKACIA was to be put back on a course for entry into the lock. The pilot assisted this by setting the pitch to 20% ahead. Shortly afterwards, the first audible alarm sounded and the pilot noticed an increase in the ship's speed. The increase in speed resulted from the fact that the pitch of the propeller blades had continued to rise to 100% and above without the control lever being operated.

The master initially attempted to adjust the pitch by operating the control lever in the normal manner, which proved unsuccessful. He then switched to backup control but it was still not possible to adjust the pitch. The investigators are of the opinion that another option to intervene did not exist.

All other measures of the ship's command, such as an emergency anchoring manoeuvre with both anchors and a main engine emergency stop failed to lead to a significant reduction in speed. Consequently, the lock gate was hit at 2354² at high speed. Part of the ship's fore section broke through the gate, her bow sustaining heavy damage in the process.

Damage caused by an earlier contact with a solid object was found on the propeller blades and inside the propeller hub during the investigation. Resulting fragments were then transported through the CPP system's hydraulics. The investigators believe one of the fragments blocked the valve needed to adjust the pitch at the time the system failed.

Nobody lost their life or was injured due to the collision with the lock gate and there was no water pollution.

¹ Nord-Ostsee-Kanal.

² Unless stated otherwise, all times shown in this report are local = UTC +1.

2 FACTUAL INFORMATION

2.1 Photograph of the ship

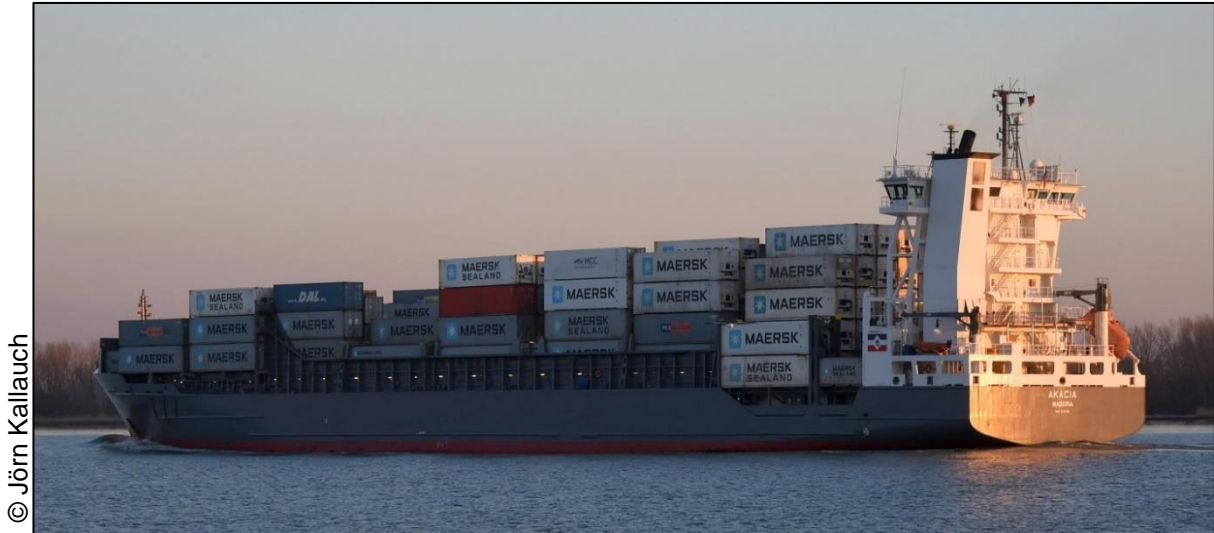

Figure 1: Photograph of the AKACIA

2.2 Ship particulars

Name of ship:	AKACIA
Type of ship:	Container ship
Nationality:	Portugal
Port of registry:	Madeira
IMO number:	9315020
Call sign:	CQIF
Shipping company:	DT-Bereederungs GmbH & Co. KG
Owner:	MS "AKACIA" Schiffahrtsgesellschaft mbH & Co. KG
Year built:	2004
Shipyard/Yard number:	J.J. Sietas Schiffswerft GmbH & Co. KG/1206
Classification society:	Registro Italiano Navale
Length overall:	149.14 m
Breadth overall:	22.5 m
Gross tonnage:	11,662
Deadweight:	13,713
Draught (max.):	8.7 m
Engine rating:	8,399 kW
Main engine:	MaK Caterpillar, 1x9M43
(Service) Speed:	18 kts
Hull material:	Steel
Hull design:	Double bottom
Minimum safe manning:	10

2.3 Voyage particulars

Port of departure:	Bremerhaven, Germany
Port of call:	St. Petersburg, Russian Federation
Type of voyage:	Merchant shipping/international
Cargo information:	Containers
Manning:	15
Draught at time of accident:	$D_f = 7.9 \text{ m}$, $D_a = 8.3 \text{ m}$
Pilot on board:	Yes
Canal helmsman:	Yes, two
Number of passengers:	Two

2.4 Marine casualty or incident information

Type of marine casualty:	Serious marine casualty; allision with lock gate
Date, time:	19/02/2018, 2354
Location:	Kiel-Holtenau, NOK
Latitude/Longitude:	$\varphi 54^\circ 21.9'N$, $\lambda 010^\circ 8.6'E$
Ship operation and voyage segment:	Estuary trading
Consequences:	Since the gate was approached at high speed, it and the ship's bow both sustained heavy damage. No fatalities or injuries and no water pollution

Extract from Navigational Chart (21) 42 (INT 1366)
of the Federal Maritime and Hydrographic Agency (BSH)

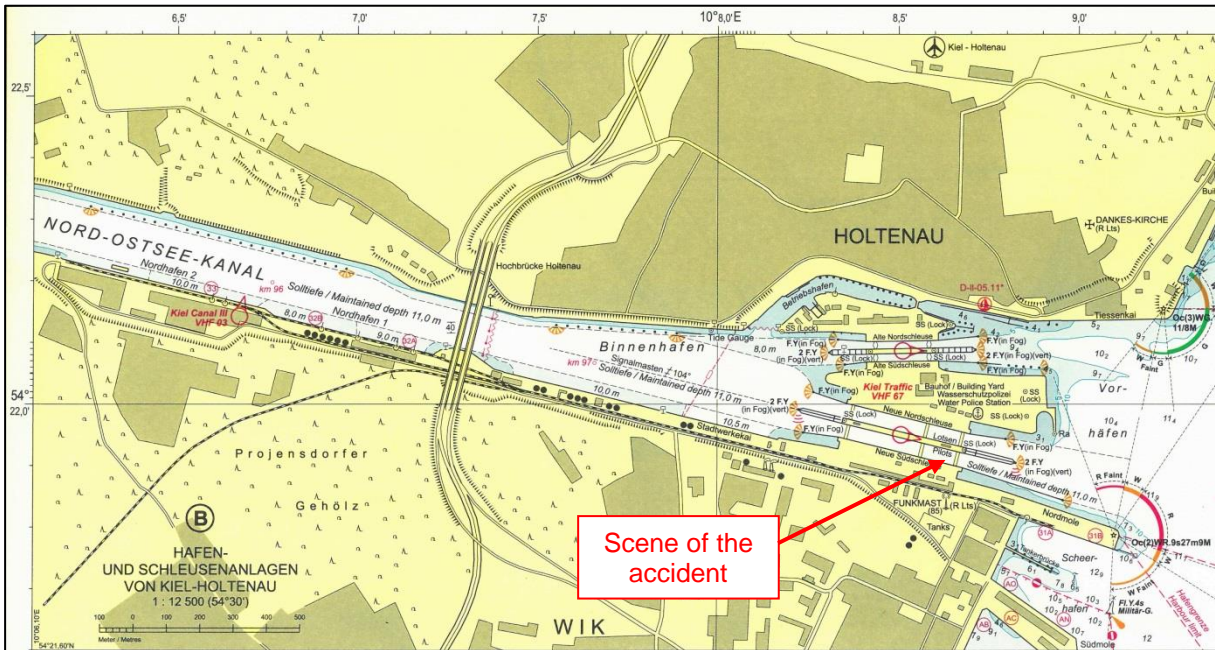

Figure 2: Navigational chart showing the scene of the accident

2.5 Shore authority involvement and emergency response

Agencies involved:	Kiel office of the Directorate-General for Waterways and Shipping (GDWS), Waterways and Shipping Office Kiel, Waterway Police (WSP) Kiel
Resources used:	Diver for the inspection of the lock gate, the bottom of the lock and the ship
Actions taken:	Ship initially made fast with lines in the lock; later she was pulled out of the lock gate and towed to a berth; even later she was repaired. Lock gate subsequently completely dismantled for removal, taken to shipyard for assessment and repaired there. Replacement gate installed
Results achieved:	Ship back in service

3 COURSE OF THE ACCIDENT AND INVESTIGATION

3.1 Course of the accident

The account of the course of the accident is based upon written statements of the crew members working on the bridge, in the engine room and on the forecastle of the ship at the time of the accident. It is also based upon statements of the pilot and the canal helmsmen, as well as upon entries in the deck log book, the bell book and the engine room log. Information gathered during the analysis of the voyage data recorder (VDR) was referenced for details. It is important to note at the same time that the recordings on the VDR did not contain any information about the rate of speed selected on the CPP system or pitch³ of the propeller blades.

3.1.1 Course of the voyage

The AKACIA, sailing under Portuguese flag, left Bremerhaven for St. Petersburg at midday on 19 February 2018. Her voyage there entailed entering one of the locks at Brunsbüttel to use the NOK at 1648 on that same day. The voyage through the canal began at 1724 under pilotage and with two canal helmsmen. Due to her dimensions and draught, the ship was classified to Traffic Group 5 for the canal passage. The pilot transfer took place in Rüsterbergen at 2054. The new pilot was familiarised with the ship's fundamentals and controls in the usual manner by the master. The pilot and the helmsmen were familiar with the ship to the extent that this type of ship often transits the NOK. According to the deck log book, there was no wind. The pilot specified eastern winds of force 2 to 3 Bft.

The pilot used the right seat inside the bridge console, from where he operated the CPP system's pitch control to manage the speed of the ship. He used the X-band radar unit on the starboard side for orientation, which was set to the display mode off-centred north-up, relative motion at a range of 0.5-0.75 nm. The S-band radar on the port side was on standby. Both canal helmsmen used the left seat in the bridge console, alternately steering the ship manually from there.

The ship sailed on her own and without any obstructions from Rüsterbergen to the Groß Nordsee siding, where she had to wait for two oncoming vessels. This involved actively reducing the speed to 2.7 kts at 2258 in the siding. There were no problems. The master, who had been out of the bridge for some time, had already reassumed command, which he retained up until the allision.

³ Pitch: Indicates the distance the propeller can cover at one revolution (with an idealised calculation). The greater the pitch angle deviates from the vertical neutral position, the greater the distance.

The pilot had already been informed in the Schwartenbek siding that the ship was allocated the Neue Südschleuse lock for exiting the NOK. The AKACIA was the only ship scheduled for this lock.

The ship passed the Projensdorf bunkering station at about 9 kts at 2340. The speed was reduced slightly when she sailed past. After that, the AKACIA encountered four westbound vessels waiting in the area of the Nordhafen port. A last switchover between the canal helmsmen took place on the bridge shortly after. The ship then continued at a decreasing speed and passed the skyway bridge at Holtenau at 7.4 kts.

At 234808, the master contacted the crew members assigned to the ship's manoeuvring stations on the portable radiotelephone apparatus, instructing them to proceed there. The port side was to be used for berthing. In each case, the person in charge confirmed this immediately.

From about this point in time, the bridge was manned by the master, second and third watchkeeping officers, pilot, both canal helmsmen, and a surveyor from the classification society. The surveyor was on board due to pending inspections.

The AKACIA had also passed the bridge by 2348. Her speed now stood at 7.1 kts. The master reported that the stern and bow thrusters were ready for use. The pilot began to set the CPP to astern at 2349. He told the master that the pitch was working⁴. According to the pilot's statement, the pitch instruction was astern (with 30% to 40% pitch).

The further reduction in speed resulted in the ship starting to veer slightly to starboard. Accordingly, the SOG⁵ at 235028 stood at 5.9 kts and at 107° in the direction ahead (HDG⁶).

According to his statement, the pilot set the pitch to zero and then to 20% ahead to help the canal helmsman with steering. When the ship had returned to the canal course, the pilot set the pitch to 40% astern again. The pilot was just about to report the astern manoeuvre to the lock master when he noticed that the speed was increasing. His visual impression was confirmed by the display of the speed on the radar unit. The pilot then checked the display for the actual pitch, which was now set to about 100% in the direction ahead.

The VDR recorded an audible alarm on the bridge for the period 235042 to 235044.

⁴ Required astern manoeuvre before entering the locks of the NOK in accordance with the general order of the GDWS – Outstation North – of 25 April 2015.

⁵ SOG: Speed over ground.

⁶ HDG: Heading.

Shortly afterwards, the pilot pointed out to the master that something was reportedly wrong and a little later advised him that the speed of the ship was increasing (235054). A continuous audible alarm could be heard on the bridge from 235059 onwards. This alarm continued until 235421.

According to his statement, the master first tried, unsuccessfully, to cancel the given pitch by setting the control lever back to astern. He then pressed the button to enable the backup control. Although the illuminated push button indicated it was enabled, the master could not adjust the pitch using the PITCH ASTERN push button, which was intended for that purpose.

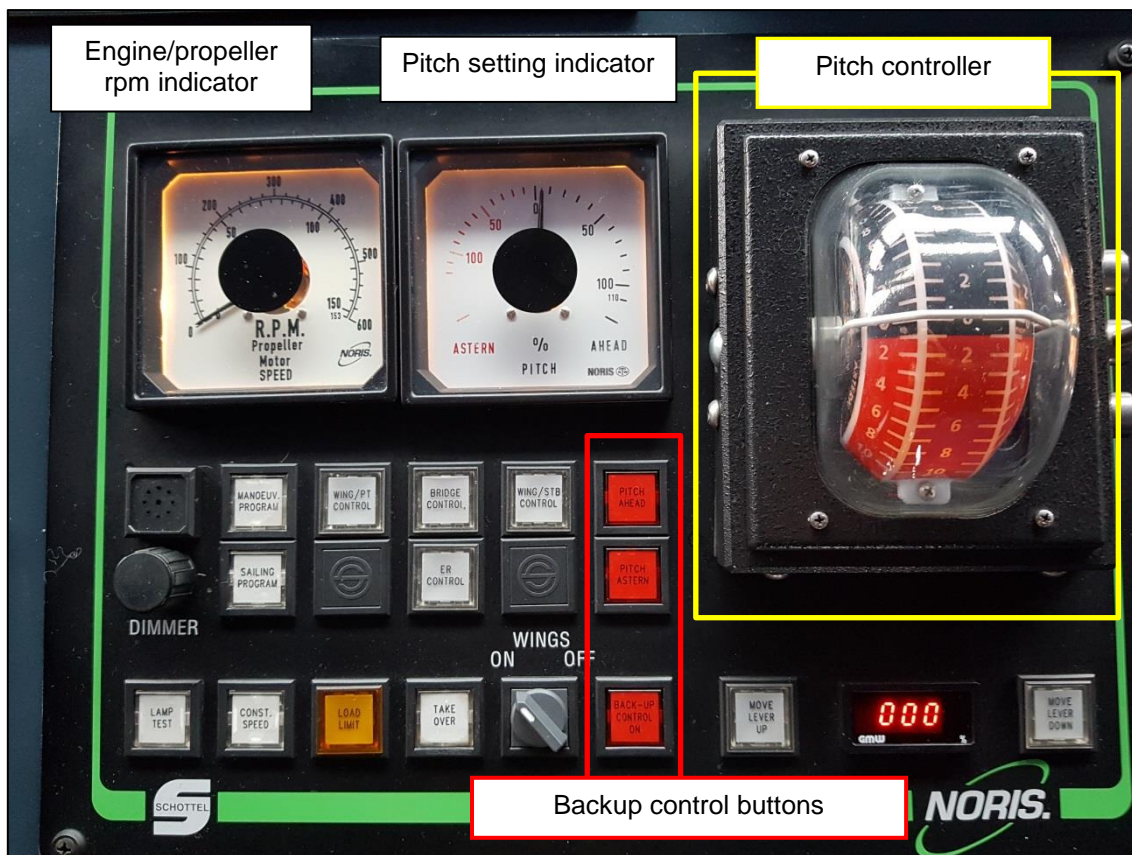

Figure 3: CPP system control panel

The speed of the ship continued to increase. Consequently, the pilot called the lock master on VHF at 235129 (call sign: Kiel Canal IV) and notified him of the problem on board the ship.

Since the master's efforts to regain control of the CPP system were unsuccessful, the pilot suggested to the master at 235156 that they drop both anchors quickly. The master complied with this suggestion immediately, instructing crew members on the fore ship by radio to drop both anchors. The master confirmed his instruction at 235209

at their request. The speed of the ship was now more than 9 kts. At 235215, the master said: "Okay, emergency stop!" He had evidently called the engine room crew by phone.

Since the crew on the forecastle stated that the anchors were ready for immediate deployment, only the band brakes had to be released. Accordingly, both anchors dropped immediately after the brakes were simultaneously released. The brakes were set again after two shots of chain cable were paid out.

At 235222, a brief signal was sounded with the tyfon.

At 235226, the pilot, in consultation with Kiel Canal IV, recommended to the linesmen to take cover, as the situation on board the ship was unchanged.

The ship passed the lock's leading jetty at 235242 at about 10.7 kts. At 235316, the AKACIA was almost completely inside the Neue Südschleuse lock. The speed at this point was 9.8 kts. Shortly beforehand, the master had once again confirmed by radio, probably in response to a radio message from the forecastle, that both anchors had dropped ("Let go. Fall the ... fall the anchors").

At 235356, shortly before the allision with the lock gate, the master ordered with "Emergency stop. Emergency stop engine!" the emergency stop of the main engine. The allision with the Neue Südschleuse lock's seaward gate occurred at 235402 on 19 February 2018 at a speed of 8.1 kts. In the process, the AKACIA sailed several metres through the gate and damaged it severely. The ship also sustained heavy damage in the bow section. Nobody was injured or lost their life due to the allision. The water was not polluted.



Figure 4: The AKACIA and the damaged lock gate

3.1.2 Additional measures

After the allision, crew members were sent to the fore section to check the extent of the damage. It was found that the bow thruster room was filled with water. The forepeak was also affected and slowly filling up.

Lines were later deployed on both sides to stabilise the ship's position. A link with the land could be established on the starboard side using the AKACIA's gangway. This enabled officers of the WSP to board for their initial measures.

As the day progressed, the Shipping Administration took the precaution of deploying an oil boom. The inner gate was closed after it had been checked for satisfactory operation. The AKACIA's anchors had not caused any damage.

3.2 Investigation

WSP Kiel notified the person on call at the BSU of the incident at 0710 on 20 February 2018. Two investigators arrived at the scene of the accident at about 1030 and began their initial investigation, by which time the WSP had already secured the data on the VDR. A copy was given to the BSU. The crew members interviewed gave a rough account of the course of events. The owner's legal counsel sent a more detailed statement to the BSU afterwards. Since the initial findings indicated a technical malfunction, the first engine room data were also saved.

3.2.1 AKACIA

The AKACIA is a Sietas 168-L full container ship without cargo gear. Her storage capacity is 1,008 TEU⁷. Her superstructure is located aft. The ship has a completely enclosed bridge without open wings. Despite the deck cargo, visibility ahead was not restricted any more than usual at the time of the accident (Figure 5).



Figure 5: View ahead from the AKACIA's bridge

The AKACIA has been managed by the current shipping company since November 2017. The ship is used for container feeder service between ports in the North Sea and Baltic Sea.

Two accidents are recorded for the AKACIA⁸ in the BSU's⁹ database (2013 and 2015). Neither accident was related to technical faults in the engine or CPP system.

The ship was in possession of valid certificates from the Registro Italiano Navale (RINA) classification society at the time of the accident. The Certificate of Class was valid until 30 November 2019. The third annual survey after the change of class had taken place shortly before on 18 February 2018 in Bremerhaven.

The crew submitted three reports on emergency drills in the engine area. During the drills, the following technical faults and their elimination or the resulting emergency measures were practised:

- 6 November 2017 – gyro compass failure, main engine failure, electrical system failure, emergency communication, emergency power supply;
- 25 November 2017 – operation of the emergency steering.

⁷ TEU: Twenty-foot equivalent unit.

⁸ Including the period 11/2004 to 01/2013 under the name BLACK SWAN.

⁹ Accidents involving ships flying the German flag anywhere in the world or ships flying a foreign flag in German territorial waters are recorded.

There is no obligation under SOLAS to conduct drills for emergency operation of the controllable pitch propeller system. According to the shipping company, during the exercises "engine failure" the functional test of the controllable pitch propeller unit was linked to this scenario. In addition, general tests of the controllable-pitch propeller system are carried out as part of the checklist for making the engine ready for sea at each departure.

3.2.2 Manning

The ship's crew consisted of 15 people (eight with Philippine citizenship, as well as one with Estonian, Lithuanian, Russian, Romanian, Polish, Ukrainian and German citizenship, respectively) when the voyage under investigation occurred. The language used on board was English. The watchkeeping officers practised a three-watch system (four on, eight off). The master was generally not on watch. Since engine operation was automated, the engineer officers did not follow a watch system during normal operation. At the time of the accident, the chief engineer officer (referred to below as CE) and the second engineer officer (referred to below as 2nd Eng.) were in the engine room in accordance with the planning for this manoeuvre. The engine rating (referred to below as fitter) was also on duty.

The Estonian master worked as a third watchkeeping officer from 1973 and has served as a master on cargo ships since 1987. His current engagement on board the AKACIA started on 1 January 2018.

At the time of the accident, the second and third watchkeeping officers were on the bridge, as the third watchkeeping officer was to be relieved at the end of the watch. Neither of them had any influence on ensuing events.

The Polish CE obtained his certificate of technical proficiency in 2003. He has served on the AKACIA since 2013 (as CE since 2016). He boarded for the current contract on 1 February 2018.

The Ukrainian 2nd Eng. has served as engineer officer on board ships since 1994. He qualified for this role in 2017 and has worked for the shipping company since 2005. His current contract started on 6 December 2017.

Shortly after arrival, the WSP carried out voluntary breathalyser tests on the master, the watchkeeping officers present, the pilot and the two canal helmsmen. Each test returned 0.00‰.

3.2.3 VDR and other technical recordings

The AKACIA is, in accordance with the regulations in force at the time of keel laying, equipped with an S-VDR G4 simplified voyage data recorder made by Interschalt. This

voyage data recorder, as permitted by the performance requirements, records neither engine data nor data relating to the controllable pitch propeller system. Accordingly, only data relating to the steering gear, the radar system used, the AIS of ships in the area and the audio recordings of the communication on the bridge and on VHF were available for the investigation. Alarms relating to the engine could thus only be identified by their audible signals on the bridge in comparison with the entries in the other technical recordings.

Due to the age of the main engine, there were no recording options available for it in an electronic logbook or fault memory. Consequently, the investigation is based upon faults recorded within the CPP's control system and upon the limited data from the engine's alarm printer (see Section 3.2.6).

3.2.3.1 VDR

The recording from the VDR covered the period 231500 (UTC) on 17 February 2018 to 234000 (UTC) on 19 February 2018. The detailed analysis of the recordings for this investigation begins 14 minutes before the allision with the lock gate.

Time	Event	v [kts]
234018	The AKACIA passes the Projensdorf bunkering bridge. Audible vibrations; the speed has reduced from 9.2 kts to 8.9 kts.	8.9
2343	Between 2343 and 2346, four oncoming vessels are passed in the area of the Nordhafen port. Continuous vibrations indicate a reduction in speed.	8.6

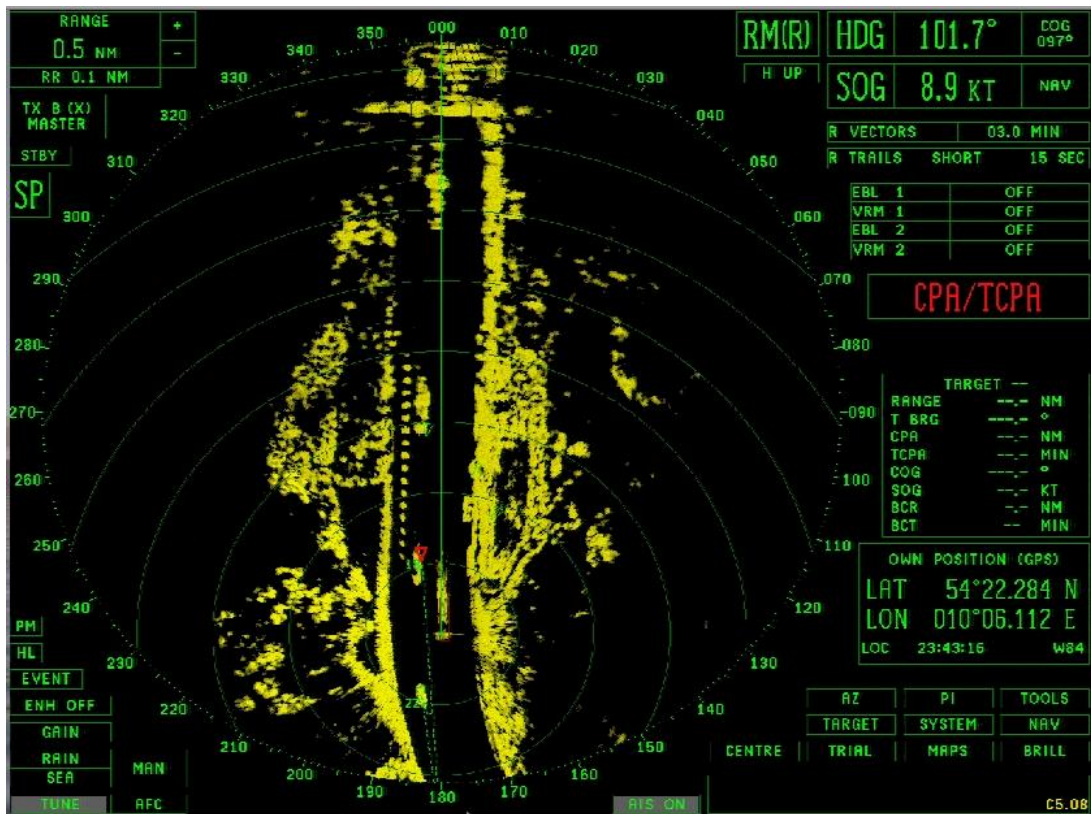

Figure 6: Radar image at 234316

Encounter with four oncoming vessels. The bridges at Holtenau are at the upper edge of the image.

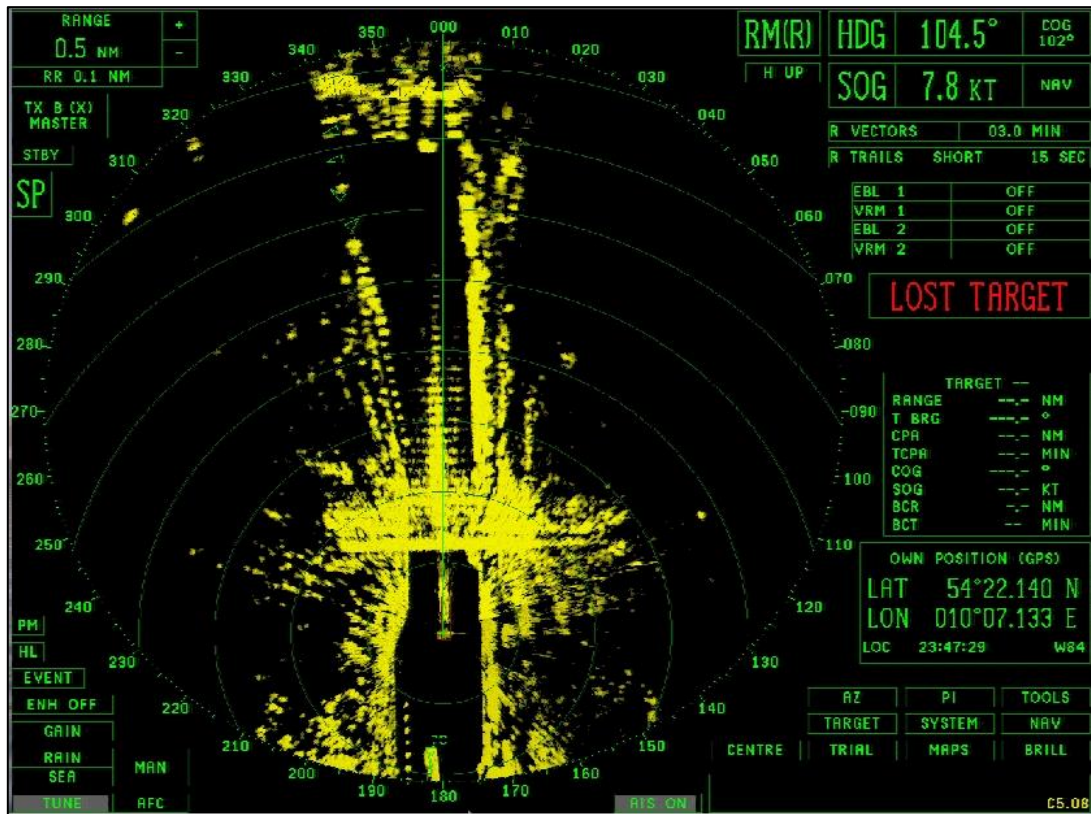

Figure 7: Radar image at 234729

Time	Event	v [kts]
234808	The master instructs the crew to proceed to the manoeuvring stations via walkie-talkie.	7.3
234846	Master: "Okay, the thrusters are ready."	7.1
234904	Increase in vibrations – evidently related to the required astern manoeuvre ¹⁰ .	
234915	Pilot: "Pitch is working!"	7.2
234927	Master: "To much speed for the thrusters."	
235014	The intensity of the vibrations decreases.	6.0

¹⁰ See also comment in footnote 4.

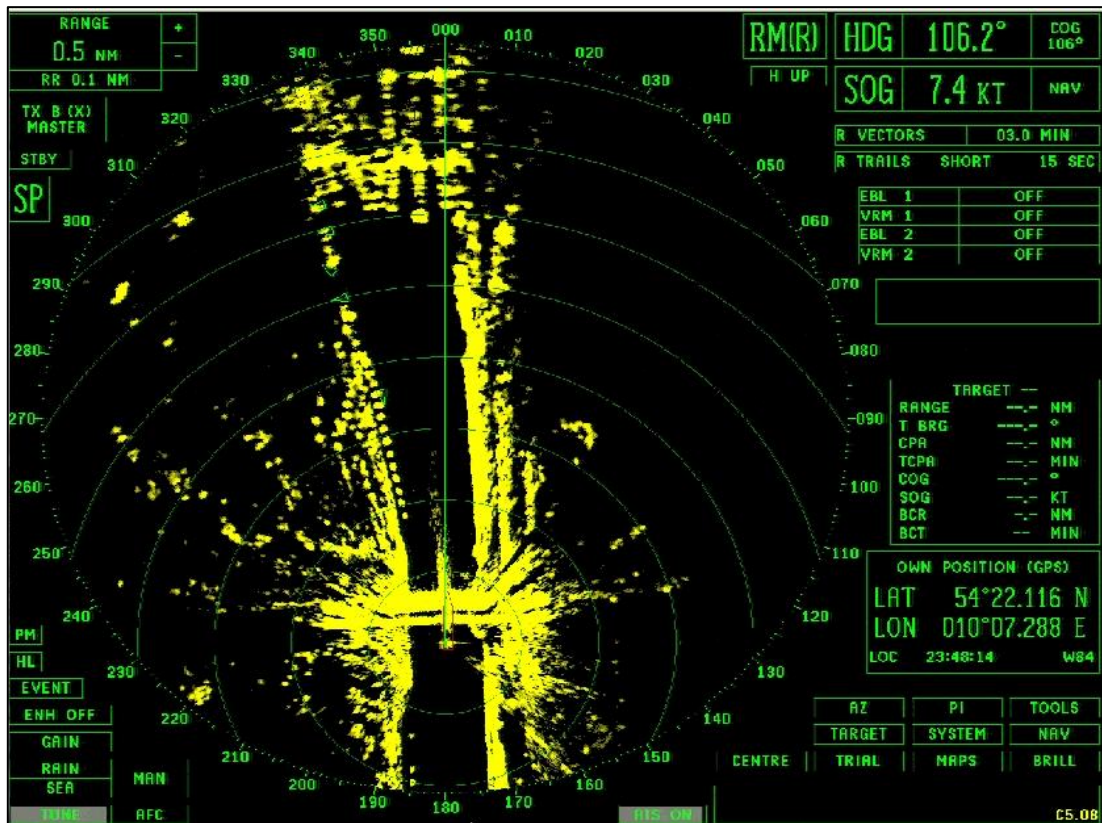

Figure 8: Radar image at 234814

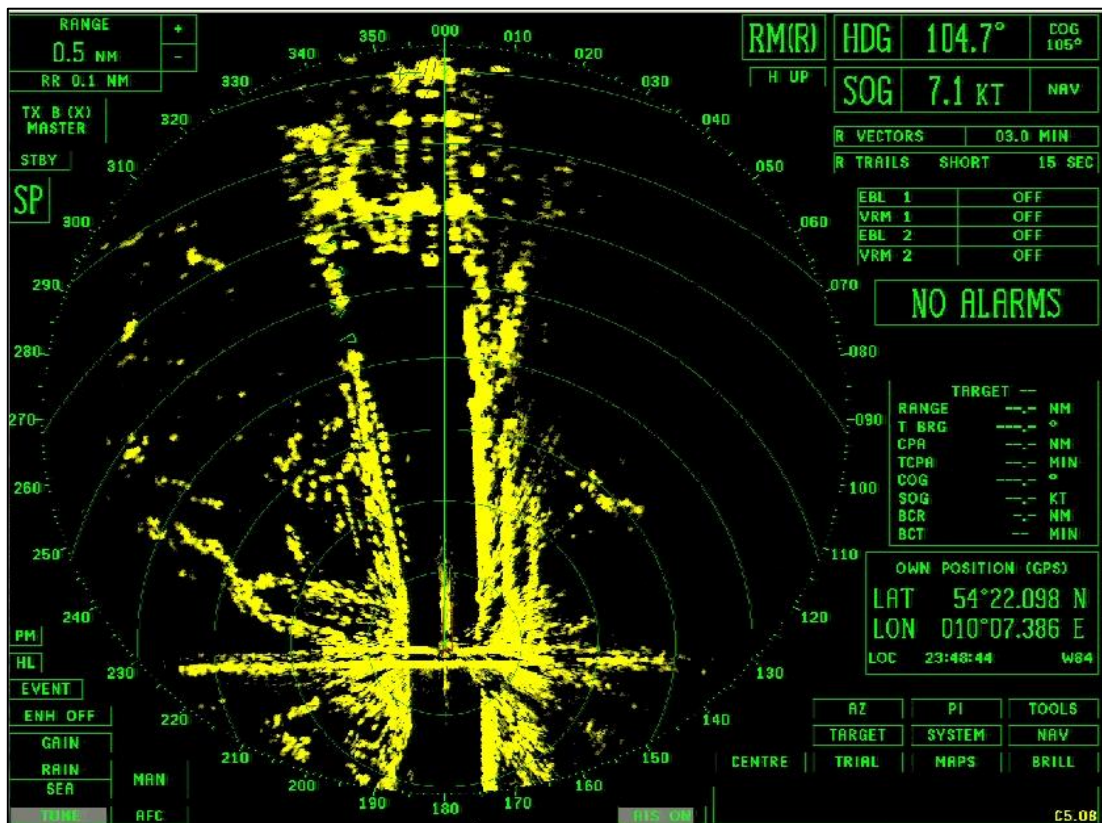

Figure 9: Radar image at 234844

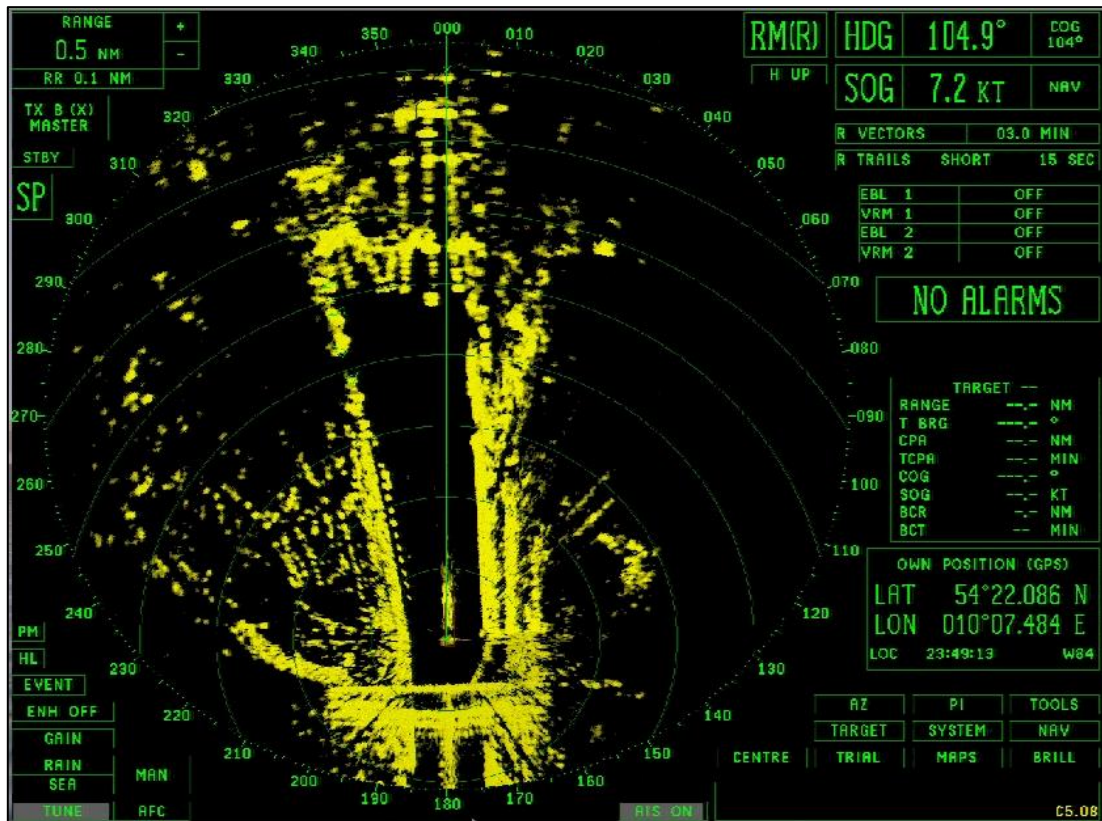

Figure 10: Radar image at 234913; "Pitch is working."

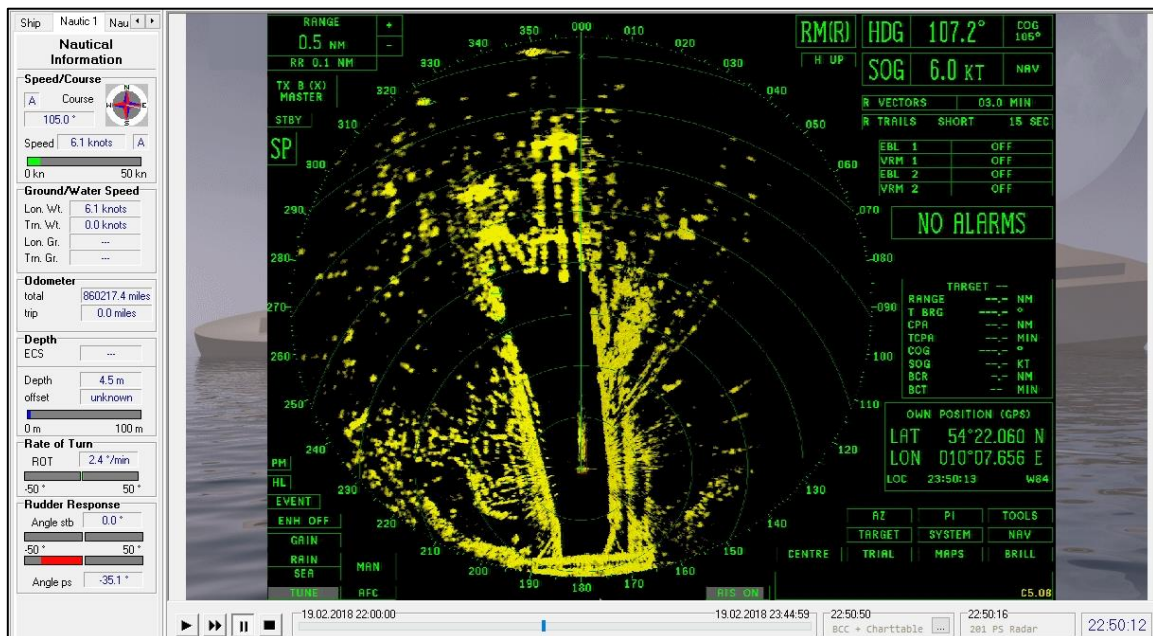

Figure 11: Screenshot of the replayer at 235013

Due to the astern manoeuvre, the AKACIA started to turn to starboard.

Time	Event	v [kts]	Distance ¹¹ [cbl]
235028	Increase in vibrations – evidently related to a pitch adjustment to ahead, made to assist with the steering.		
235039	Time of the lowest speed.	5.9	
235042	Audible alarm for three seconds.	6.3	4.9
235047	Pilot: "Captain, there is something wrong!"		
235054	Pilot [forceful]: "You see, we are speeding up!"		
235059	A new audible alarm sounds.	7.2	4.7
235108	Pilot [more forceful]: "We are speeding up!"		
235121	Pilot [very forceful]: "I have no engine here!"		
235126	Master [mutters]: "Emergency stop."		3.9
235129	Pilot: "Kiel Canal IV for AKACIA!"	8.6	
	Kiel Canal IV: "AKACIA – Kiel Canal IV."		
235135	Pilot: "We have real engine problems here. The engine is at full ahead."		
235135	A new alarm sounds for seven seconds.		

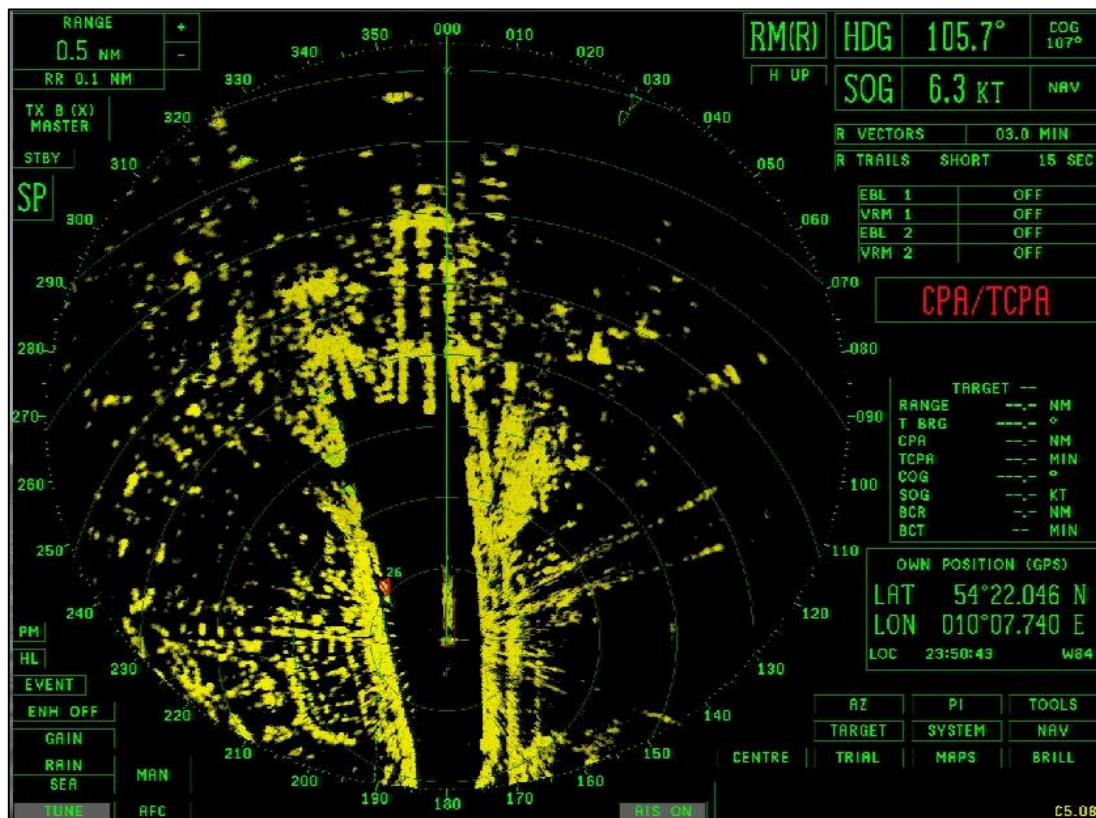

Figure 12: Radar image at 235043

¹¹ Approximate distance from bow to the seaward lock gate. The distance between the antenna and bow of the ship is about 139 m (0.76 cbl).



Figure 13: Radar image at 235058



Figure 14: Radar image at 235127

Time	Event	v [kts]	Distance ¹² [cbl]
235142	Unidentified person on the bridge: "Does he not have an emergency stop?"	9.2	
235151	Kiel Canal IV: "Is the anchor ready? If so, they could still drop anchor. After is bad."		
235156	Pilot [demanding]: "Let go both anchors, captain!"		3.1
235158	Master (call via walkie-talkie) [also demanding]: "Let go both anchors. Let go both anchors!"	9.7	
235209	Master repeats order to drop anchors after follow-up inquiry over radio. A phone rings.		2.8 (235212)
235215	Master): "Okay, emergency stop." The phone is then hung up.	10.1	
235222	Short blast with the tyfon.		
235226	Pilot: "Take the people into cover Kiel Canal IV. Nothing at all is coming."	10.4	2.5
235230	Pilot curses.		



Figure 15: Radar image at 235157

¹² Approximate distance from bow to the seaward lock gate. The distance between the antenna and bow of the ship is about 139 m (0.76 cbl).



Figure 16: Radar image at 235212



Figure 17: Radar image at 235227

Time	Event	v [kts]	Distance ¹³ [cbl]
235232	Audible vibrations for the next 16 seconds.		
235245	Pilot: "This cannot be happening."	10.7	1.9
235248	Master (further away from the microphone): "Let go both anchors."		
235257	Pilot: "Madness."		
235311	Information over walkie-talkie from the forecastle (inaudible).		
235314	Master: "Let go. Fall the ... fall the anchors." ¹⁴	9.8	1.0
	Vibrations of a different frequency can be heard.		
235356	Master (to unknown addressee): "Emergency stop. Emergency stop engine!"	8.1	0.2
235402	Allision with lock gate. Audible alarm continues.		
235421	Audible alarm off.		



Figure 18: Radar image at 235312

¹³ Approximate distance from bow to the seaward lock gate. The distance between the antenna and bow of the ship is about 139 m (0.76 cbl).

¹⁴ According to the shipping company, the captain says: "Let go. All the ... all the anchors." The master's statement is understood by the shipping company as a confirmation and reaction to the radio message from the forecastle.

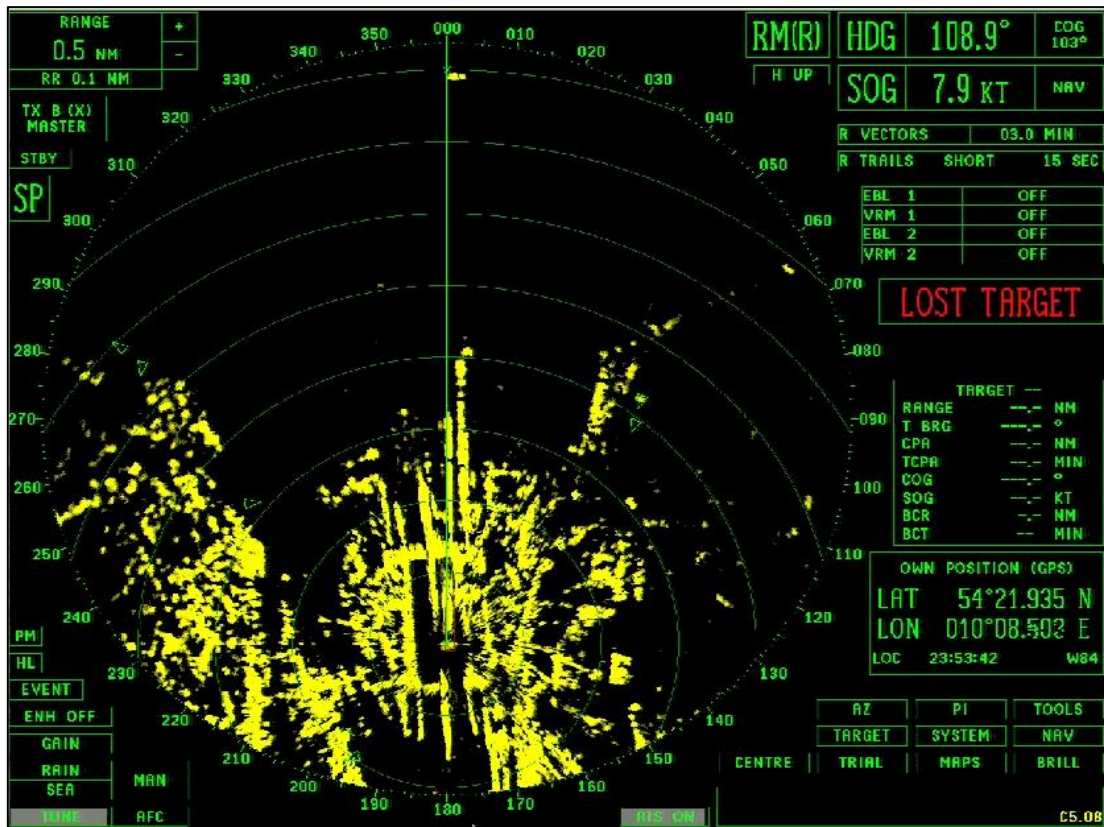

Figure 19: Radar image at 235342

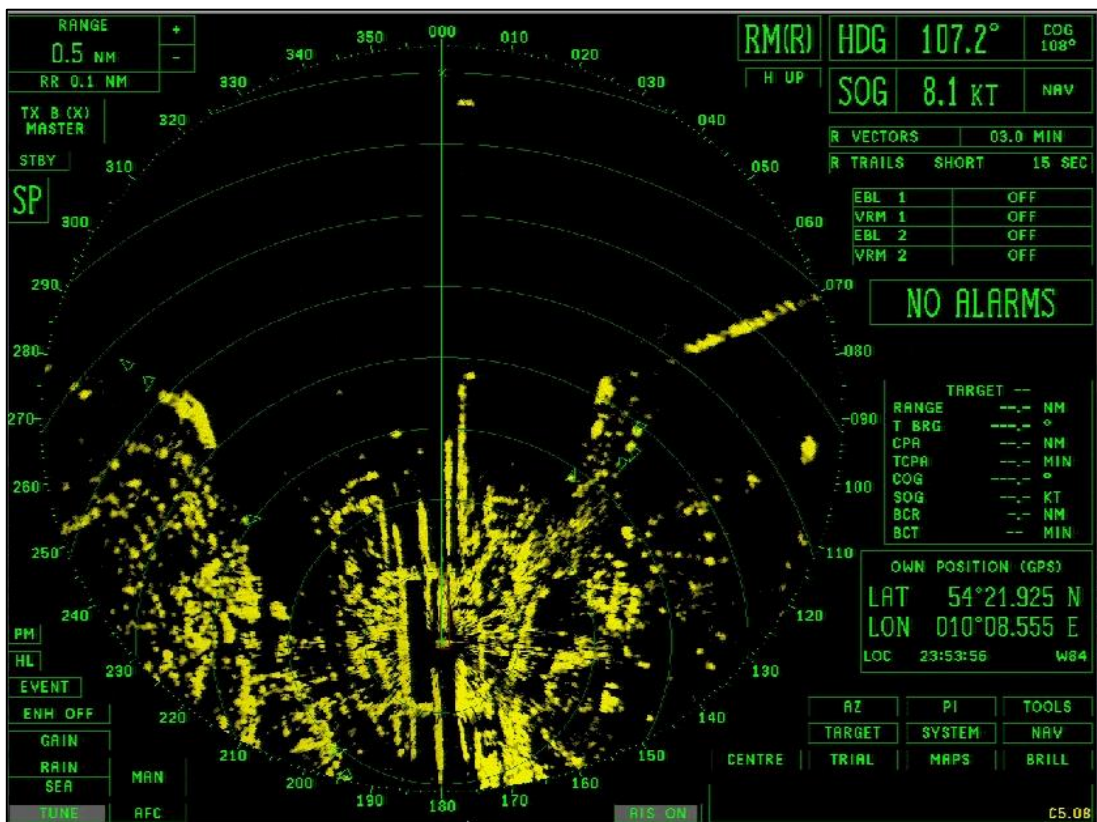

Figure 20: Radar image at 235356; "Emergency stop."

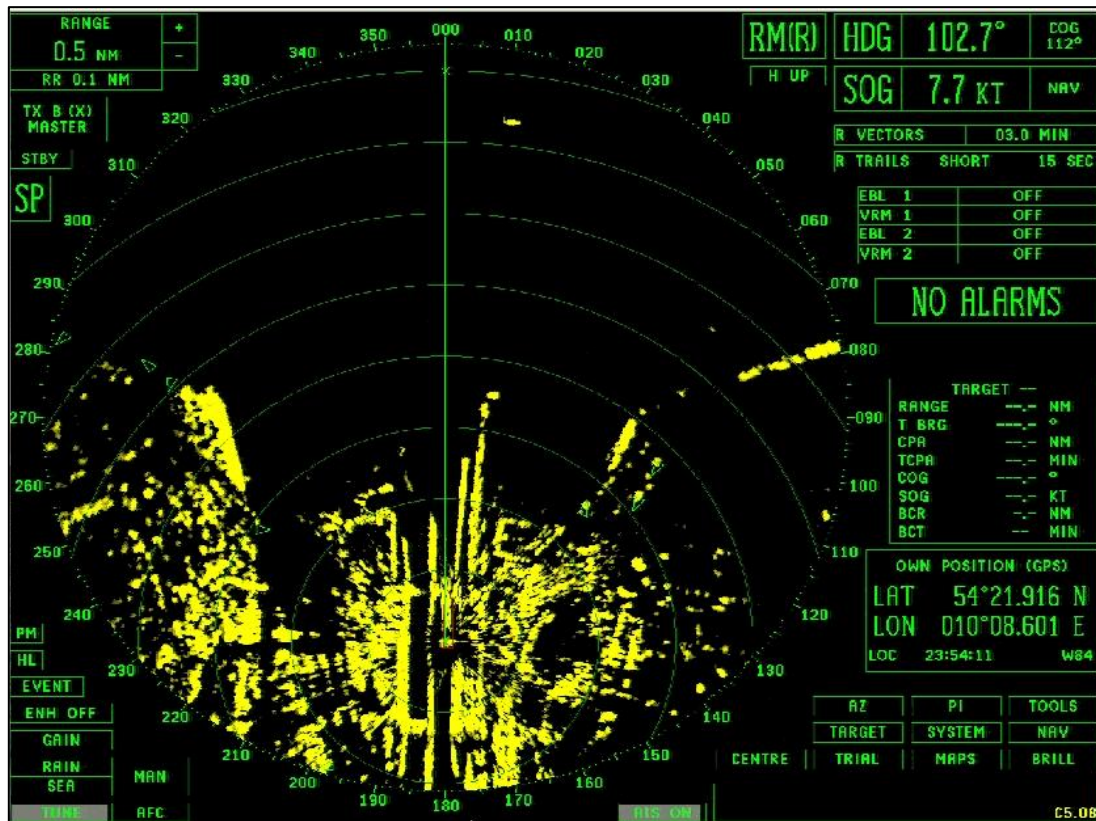

Figure 21: Radar image at 235411

3.2.4 CPP system

3.2.4.1 Description of the CPP system

The AKACIA is equipped with a controllable pitch propeller system. Thus, at a constant speed of the main engine, changes in the ship's speed or direction of travel can be effected solely by adjusting the propeller blades.

The basic design of the AKACIA's propulsion system is shown in Figure 22. The components of the CPP system that are visible in this figure are shown in grey. This includes the controllable propeller with controllable blades, the propeller shaft and the oil supply, which is referred to below as oil distribution box (OD-box). The OD-box is located before the reduction gear (gearbox) in the direction of travel.

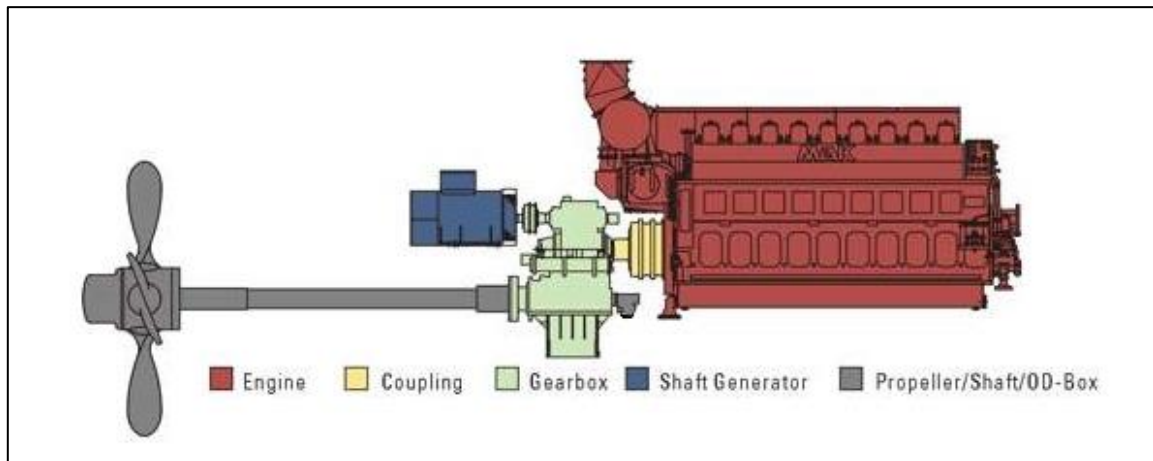

Figure 22: Design of the propulsion system¹⁵

The AKACIA is fitted with a SCHOTTEL SCP 141 4XG CPP (see Figure 23). The name has the following meaning:

- SCP: SCHOTTEL Controllable Pitch Propeller
- 141: size of the CPP hub (diameter in cm)
- 4: number of propeller blades
- X: the hydraulic cylinder is inside the propeller hub
- G: the OD-box is located upstream of the gearbox

The tank shown on the left in Figure 23 holds the oil required to lubricate the stern tube. The tank on the right contains the hydraulic oil for the CPP system. The oil both moves the piston and lubricates the moving parts within the propeller hub.

¹⁵ www.dieseldruck.info/machine/02%20propulsion/shafting/index.htm, retrieved 15 May 2019.

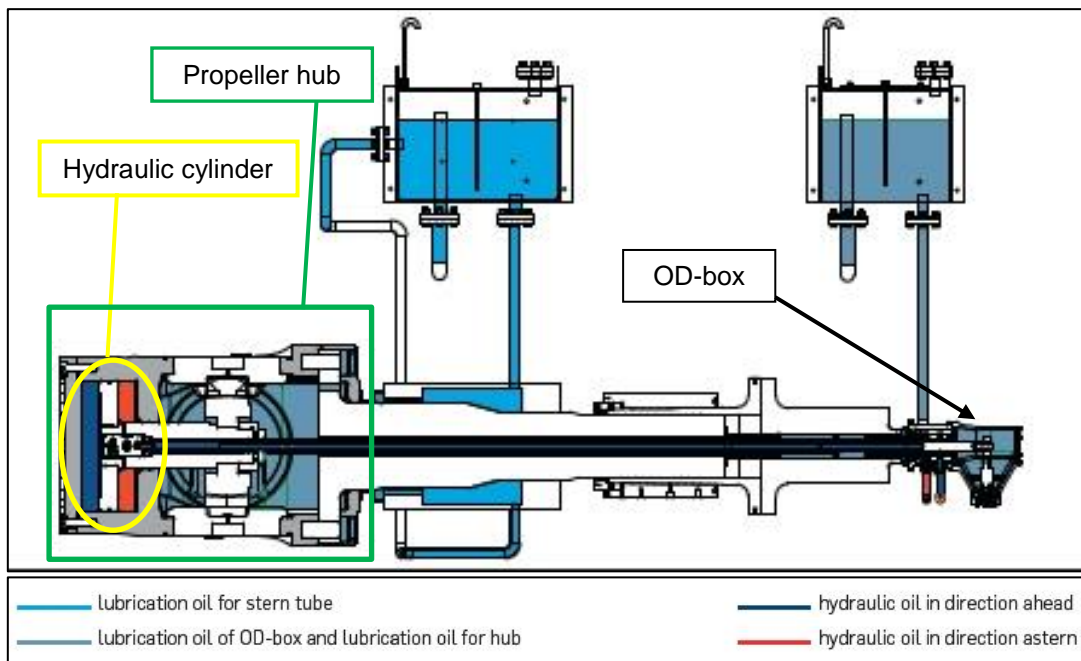

Figure 23: Diagram of a SCHOTTEL SCP_XG system¹⁶

The hydraulic cylinder for rotating the propeller blades is positioned within the propeller hub. The OD-box is installed upstream of the gearbox. The hydraulic power unit and supply line for the OD-box are not shown.

The AKACIA's CPP system comprises the usual components, as listed below.

3.2.4.2 Hydraulic power unit

The hydraulic power unit comprises a tank containing the oil for driving the hydraulic cylinder. Two corresponding electrically operated pumps are mounted above the tank. In each case, one of the pumps is able to build up the pressure required in the system during normal operation. The nominal pressure is 80 bar ± 5 bar. Other material elements of the hydraulic power unit are the two filter elements mounted outside the tank, each of which uses one filter, and the proportional valve (Figure 25).

After being sucked in by the pumps, the oil first passes a non-return valve and then one of the two filter elements. It then flows through the proportional valve. The proportional valve is a 4/3-way directional valve. This means that the valve has four connections and three switching positions. This valve is used to set the position/pitch of the propeller blades selected on the pitch controller on the bridge (Figure 3). The valve activates the oil flowing from the pump (supply **P** – first connection) for one of the two directions of movement of the pitch adjustment (see Figure 24). If no pitch adjustment is necessary, then the oil pressure in the system is reduced by a pressure reducing valve after passing the proportional valve and the oil flows through the oil cooler back into the tank (return flow **T** – second connection).

¹⁶ Taken from the CPP's brochure: <https://www.schottel.de/de/schiffsantriebe/scp-verstellpropeller>. Information as of 20 December 2018.

When a pitch adjustment is made, the proportional valve adjusts accordingly and either activates the line for the adjustment in the direction ahead (**A** – third connection) or the line for the adjustment in the direction astern (**B** – fourth connection) for the two lines to the OD-box. The oil flows to the corresponding side of the hydraulic cylinder and moves it to the required position. The oil contained in the hydraulic cylinder chamber previously pressurised flows back into the tank through the proportional valve and the oil cooler.

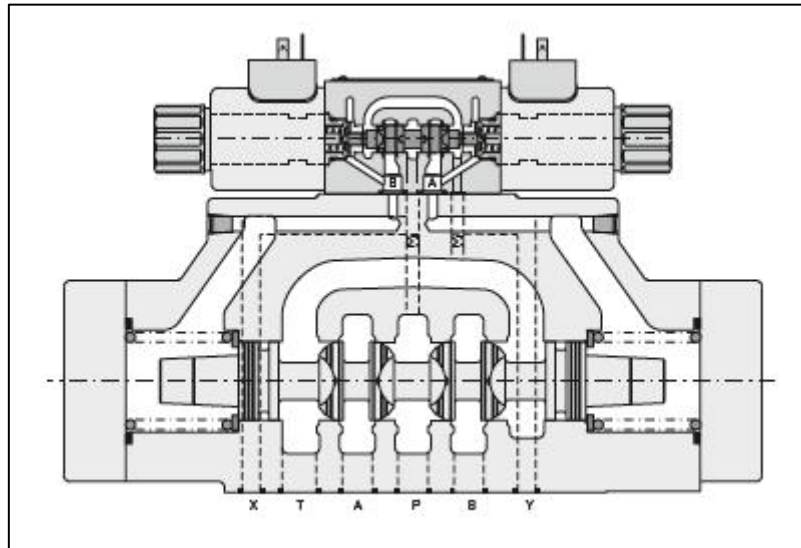

Figure 24: Side view of the proportional valve

Accordingly, the switching positions are: 1. ahead, 2. astern, 3. return flow. The adjustment in the direction astern does not necessarily mean that the ship will move astern, however. For example, it can also mean only an adjustment of the pitch from 100% ahead to 50% ahead and vice versa.

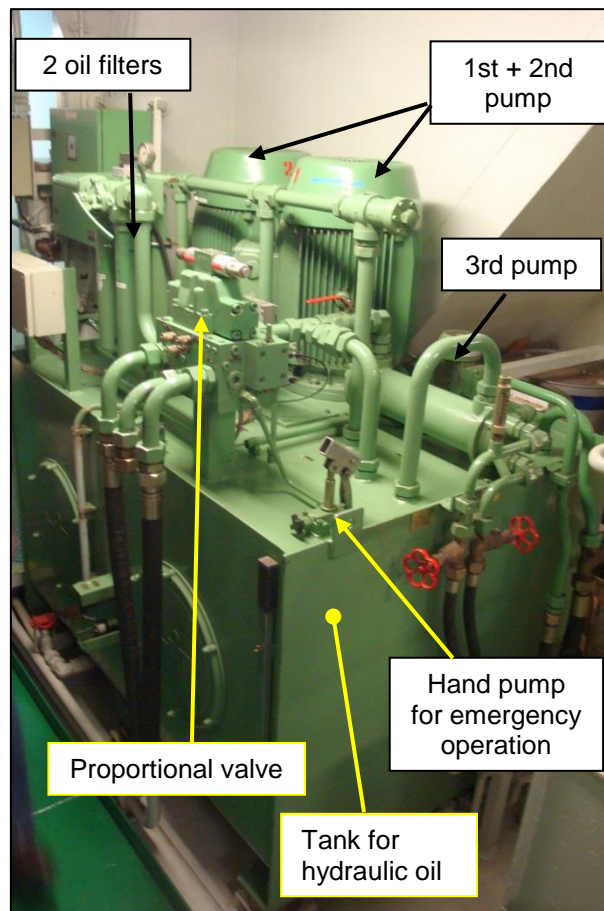

Figure 25: Hydraulic power unit

In addition, a third, smaller pump is installed on the tank to maintain the circulation of the hydraulic oil.

3.2.4.3 OD-box

The OD-box is positioned as a kind of flange on the hollow propeller shaft. It establishes the connection between the oil lines located outside and inside the propeller shaft. The current pitch of the blades is simultaneously recorded in the OD-box and transmitted to the control system.

In addition to the hydraulic cylinder in the propeller hub, the remaining part of the hub is also supplied with oil from the hydraulic system via the OD-box (see Figure 23).

3.2.4.4 Propeller shaft

The nested oil lines are directed to the propeller hub inside the propeller shaft.

3.2.4.5 Propeller hub

The rotatable propeller blades are mounted on the propeller hub. The hydraulic cylinder/piston is positioned within the propeller hub. The direction of the blade pitch

can be altered depending on the surface to be acted upon, i.e. the front or back of the piston. In the propeller hub, the axial displacement change of the hydraulic piston is converted into a rotary motion or pitch adjustment of the propeller blades by the mechanics located there.

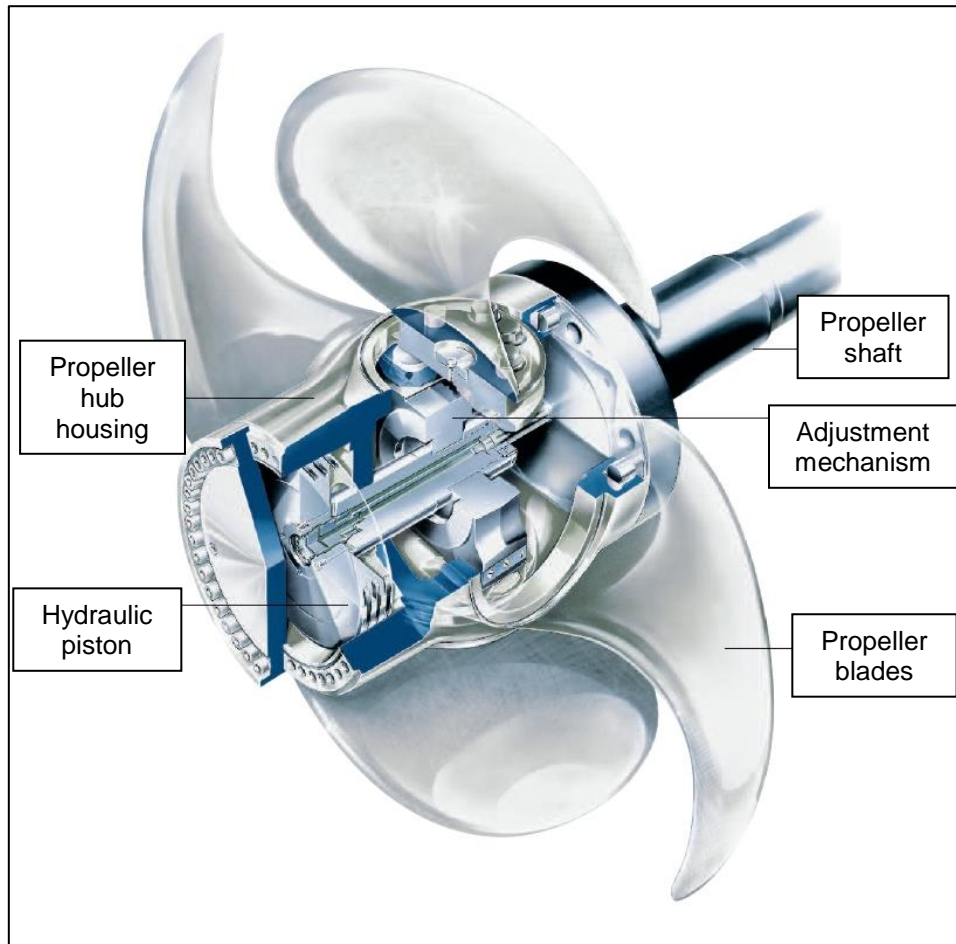

Figure 26: Propeller hub¹⁷

3.2.4.6 Overview of the hydraulic system for adjusting the blades

In the interest of clarity, a schematic drawing of the CPP system's hydraulic system is shown below.

¹⁷ Taken from the CPP's brochure: <https://www.schottel.de/de/schiffsantriebe/scp-verstellpropeller>. Information as of 20 December 2018.

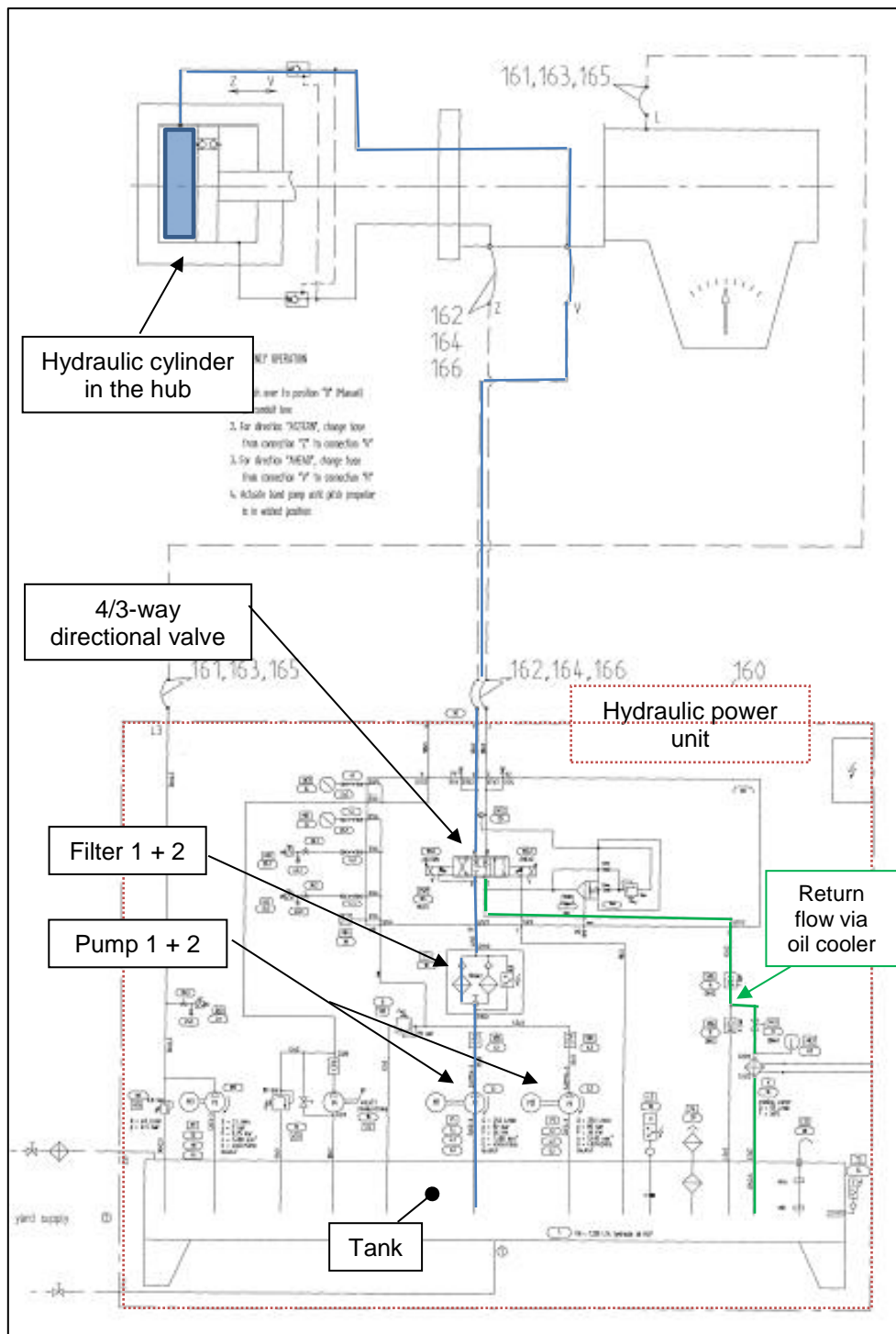

Figure 27: Schematic drawing of the hydraulic system¹⁸

The path of the hydraulic oil for an adjustment in the direction ahead is shown in blue. If no adjustment is made, the oil is returned to the tank (return flow; shown in green).

¹⁸ Figure taken from SCHOTTEL's documentation for the SCP 141/4-XG CPP system.

3.2.4.7 Control options for the CPP system

3.2.4.7.1 Normal operation

Normal pitch adjustments can be made using the pitch controllers on the bridge (one in the central bridge console and one in each wing) or the pitch controller in the engine room. On the bridge all three pitch settings are adjusted using the pitch controller shown in Figure 3. In the engine room this is carried out using the rotary knob in the upper right field (Figure 28).



Figure 28: CPP system's control panel in engine room
Control was on the bridge when the photograph was taken.

Basically, two computer-assisted modes are possible in normal operation. One is the combinator mode. This is where the pitch and rated speed of the engine are controlled using the pitch adjustment control lever. The relation between rated speed and pitch is set by the system using curves stored in the controller.

At the time of the accident, the entire control system was operated in the second operating mode (constant engine speed mode). Only the pitch of the propeller blades is determined using the control lever. The system keeps the engine's rated speed constant. This means that it is only when the main engine is overloaded that the propeller pitch is automatically reduced according to the manufacturer's load curve. This operating mode is usually selected during manoeuvring when the shaft generator is operated at the same time.

3.2.4.7.2 Backup operation

In the event of a system malfunction, the pitch can be adjusted using the backup control. This is possible at all control panels on the bridge and at the pitch controller in the engine room. The backup control bypasses the computer and acts directly on the proportional valve. The pitch is adjusted in the direction ahead or in the direction astern by means of the push buttons on the control panel. The current pitch can be read on the pitch adjustment display.

The backup control is switched on by pressing the BACK-UP CONTROL ON button (Figure 29). The pitch is then adjusted by pressing the PITCH AHEAD or PITCH ASTERN button. During operation of the backup control, the TAKE OVER key flashes. This button is pressed to return the system to normal operation. The position of the operating lever and the actual pitch need not be the same for this purpose.

Main and backup controls are not designed to (and do not need to) detect whether there is a mechanical fault within the system, for example in the proportional valve. Therefore, switching to the backup control is possible as long as there is no electrical fault. An existing electrical fault that prevents switching would result in the "BACK-UP CONTROL ON" button not lighting up.



Figure 29: Detail of the CPP system's control panel at the bridge

3.2.4.7.3 Emergency operation

In the event of a more serious system failure, an adjustment can be made directly at the proportional valve by manual operation when the hydraulic pumps are still running (see Figure 30).

If the pumps fail, pump pressure can be generated by means of a hand pump. However, an adjustment is then no longer possible while the propeller shaft is rotating. A more detailed description is not given here, as the hydraulic pumps did not fail. According to the CE, it takes about 1.5 minutes to switch to this mode.

A description of the emergency operation was located directly at the hydraulic power unit. The sheet shrink-wrapped in a foil showed that the emergency measures are part of the Safety Management System manual.

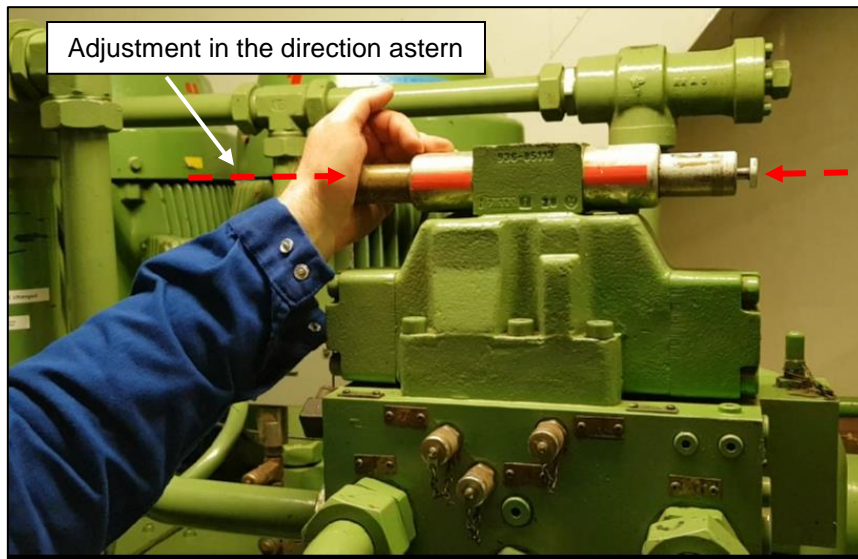

Figure 30: 4/3-way proportional valve and manual operation

3.2.5 Examination of the CPP system

3.2.5.1 Determination of the different system times

A display for certain information and alarms can be found on the front of the CPP system's central unit in the engine control room (ECR).

The investigators first inspected the contents of the data provided there on 20 February 2018 during the initial survey of the ship. It was found that the first alarm associated with the further course of the accident was displayed with the following information (see Figure 31):

“1 00093 19.02.18 14:17:33 error pitch / pitch controller”

The investigators believe that the related printout of the alarm printer in the ECR is (see Figure 32):

“01A4 01.02/0824 AL1 Remote Contr. Fail. CPP ON”

This printout was also noted during the first survey. It should be noted that the printout is only accurate to the nearest minute.

The first – in the opinion of the BSU investigators – associated audible alarm on the bridge started at 225042 UTC¹⁹ (or 235042 local/ship's time) on 19 February 2018. Since the radar images shown in Section 3.2.3.1 are based on local time, this will be used as the reference time below.

¹⁹ According to the audio recording on the VDR.

Accordingly, the difference between local time and the CPP system's time was -09:33:09 hours. The time difference between local time and the alarm printout for the engine was -18 days 15 hours 26 minutes.

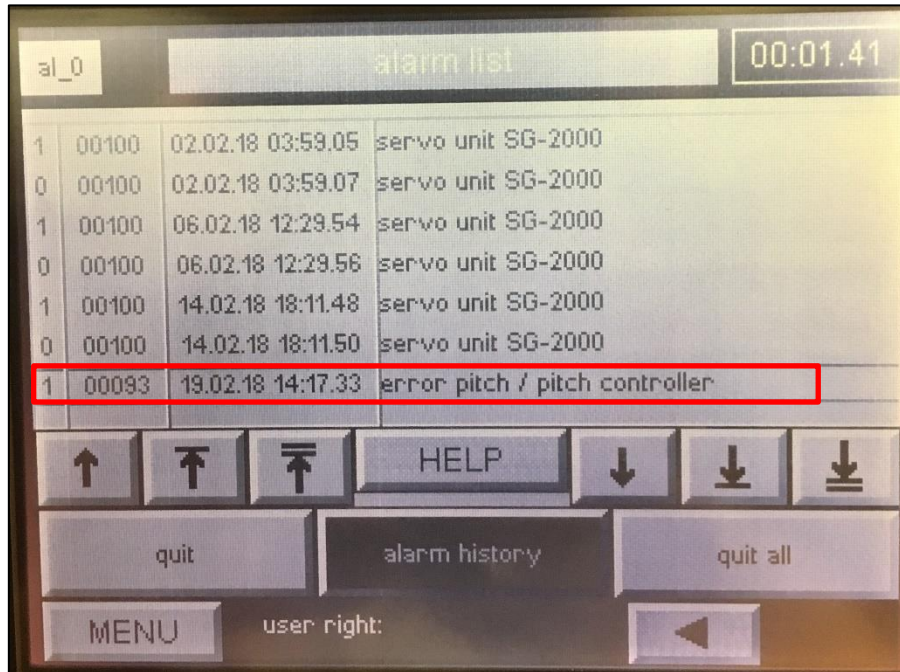

Figure 31: First alarm associated with the accident
 Extract from the CPP system central unit's alarm log

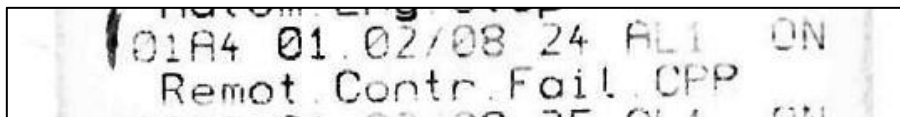

Figure 32: Extract from the printout of the alarm printer in the ECR

3.2.5.2 CPP system error messages

There is no display on the bridge of the ship which could show various error messages from the controllable pitch propeller system in any way. Function or non-functioning is only indicated by the illumination of signal lamps in the control panel. A "non-function" refers only to the electrical part of the control system.

The display in the door of the switch cabinet of the controllable pitch propeller system (see Figure 31), located in the engine control room, only gives error messages which refer to the electrical part of the control system. A possible mechanical cause cannot usually be deduced directly from the error messages.

The first error message occurred at 235042 (141733 + 9:33:09 hours) as stated above. The message (see Figure 31) indicated an error in the control system. The meaning of error message 00093 is shown in Figure 33. The error occurs when the difference between the pitch setpoint and actual pitch value exceeds a specified value. This error could not

be read on the bridge, where only an audible alarm was issued (235042). However, it did become apparent on the bridge that the pitch of the propeller blades was rising to 100% without the influence of the adjusting lever. The pilot brought this to the master's attention at 235047: "Captain, there is something wrong."

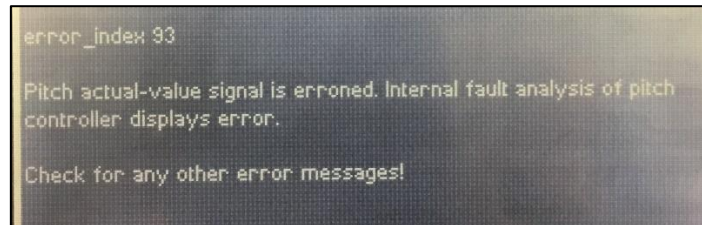

Figure 33: CPP system (meaning of error 00093)

1	00094	19.02.18 14:17.52	2. actual pitch signal back-up-system
0	00093	19.02.18 14:18.41	error pitch / pitch controller
1	00100	19.02.18 14:19.06	servo unit SG-2000
1	00093	19.02.18 14:19.06	error pitch / pitch controller
0	00100	19.02.18 14:19.10	servo unit SG-2000
0	00094	19.02.18 14:19.46	2. actual pitch signal back-up-system
0	00093	19.02.18 14:19.57	error pitch / pitch controller

Figure 34: Extract from the CPP system's alarm log

The messages following the first alarm (141733) are shown here (see Figure 29).

The next error message was generated at 235101 (141752): '2. actual pitch signal back-up-system'. This error (Figure 35 (error 94)) occurs when the pitch display exceeds the set maximum value of 100%. The pitch reached 110%.

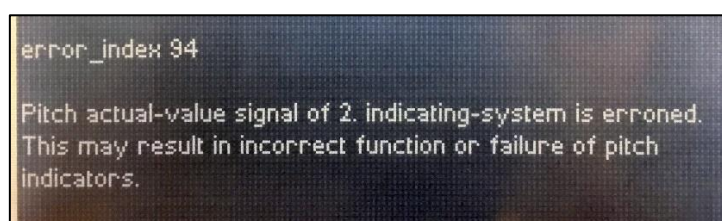

Figure 35: CPP system (meaning of error 00094)

At 235150 (141841), the first error message (value '0' in column 1) deactivated (Figure 34). According to the manufacturer, this is the case when the error no longer exists or the backup control is activated. The investigators believe that operation of the backup control by the master was the cause.

At 235215 (141906), the error message 'servo unit SG-2000' was displayed. At the same time the 'error pitch/pitch controller' message reactivated. The investigators

assume the master had switched from backup control back to normal control at that time. As a result, the previous error message (error 93) reactivated.

The error "servo unit SG-2000" is a collective alarm generated within the SG2000 unit, a servo controller for controlling the proportional valve. The error occurs on the one hand when the system is switched on. On the other hand it occurs when switching between the main control and the emergency control. In these cases the control loop is interrupted or switched on again, which triggers the error.

The system recorded the error, which lasted only a few seconds (3-5 seconds) in each case, several times before. Tracing back the alarms to 30 December 2017 revealed the aforementioned correlation with switching on the system during six departure manoeuvres, as well as one departure from a roadstead. A total of 16 departure manoeuvres and one departure from a roadstead were counted in the period under consideration. The error therefore does not occur regularly in this context. It stands to reason that in these cases the installation was not switched off during the time the vessel was in port.

In the case of the error message at 23:52:15, the investigators assume, as already explained, that the error was generated when the control loop was switched back on. The message "servo unit SG-2000" went out after 4 seconds at 23:52:19 hrs.

At 235255 (141946), the '2. actual pitch signal back-up-system' error message was deactivated. In the investigators view the error causing the pitch to rise to 110% no longer existed. This means that the pitch had returned to a value below 100%.

At 235306 (141957), the 'error pitch/pitch controller' error also went out. On one hand, this could be related to the deactivation of the '2. actual pitch signal back-up-system' error. The original error may no longer have existed, i.e. the system responded again and the propeller's pitch had returned to the range of the pitch adjustment control lever position. However, the alarm is cancelled if the difference between process value and setpoint is less than 40% or 60%.²⁰ Therefore, the pitch did not have to return to the value corresponding to the position of the operating lever to deactivate the alarm. However, the control lever's position at that time is unknown.

3.2.5.3 Other findings on the hydraulic system

The AKACIA was visited several times during the investigation to continue the enquiries from various points of view. The investigations were carried out alongside the owner's expert and the WSP's investigators.

²⁰ The exact value is unknown to BSU. It is set by the manufacturer according to the requirements of the respective shipyard.

During the first survey of the ship and the hydraulic system on 20 February 2018, information on the filter elements indicated that they had been replaced on 5 December 2017. The crew then carried out a filter change on 21 February 2018 and labelled the filter cartridges accordingly. According to the crew, the change was made on the basis of a change interval specification. The WSP found the old filters on 22 February 2018 in a tank filled with a cleaning agent (carbon remover). The WSP secured one of the filters and kept it as evidence.

In the context of the investigation, the following data on oil changes and surveys of the CPP system were found:

- last oil change in the propeller hub during the dry docking for the class survey: 11/10/2014;
- last survey of the propeller hub and the propeller blades during a dry docking: January 2017 – no anomalies; included overhaul of the OD-box (which was the manufacturer's last service on the system);
- preceding tests of the CPP system's oil:
 - o 23/11/2016 – no anomalies²¹
 - o 24/03/2017 – no anomalies
 - o 20/06/2017 – no anomalies
 - o 25/10/2017 – no anomalies

During the hearing, the shipping company submitted the test results of another oil sample taken on 18 February 2019. No abnormalities of this sample could be detected in comparison with the previously analysed samples regarding the markers for contamination or wear. A test of the degree of purity in the sense of the ISO standard 4406/1999 was not carried out due to visible sediments. At the time of the accident, the findings were not yet available to the shipping company or the crew. The test result had been classified as "normal" by the laboratory.

On 01.03.2019 under supervision of the WSP Kiel the crew took an oil sample of the hydraulic oil at the proportional valve. Also no abnormalities of this sample could be detected in comparison with the previously analysed samples regarding the markers for contamination or wear or the trend. The contamination level according to ISO standard 4406/1999 was 16/12/7 compared to the specified purity class of 15/13/10 for such oils.

Oil samples were taken from the propeller hub and stern tube in the presence of the BSU on 19 March 2018. For these oil tests commissioned by the BSU and carried out by an approved laboratory, the BSU only had a comparative result for sterntube oil dated 20.10.2017. The markers for contamination and wear and their trend did not show any abnormalities in either sample. As the purity class was not determined for the sample of 20.10.2017, a comparison with the determination of 19.03.2018 was not possible.

²¹ The test report shows that the three samples analysed before (from November 2015) were also within the purity class 15/13/10 according to ISO standard 4406/1999.

Basically, the oil of the propeller hub is not subject to continuous inspection and can only be tested when working on the hub.

3.2.5.4 Damage to the propeller blades

The AKACIA was surveyed on 12 March 2018, by which time she had been moved to Hamburg and dried in a floating dock at the Norderwerft shipyard. Damage to the propeller blades was found during the survey of the hull and propeller in the dock.



Figure 36: Damage to one of the propeller blades



Figure 37: Close-up of the damage

The damage to the propeller blades was re-examined on 19 March 2018 and remnants of line were found in cracks in one of the accessible propeller blades.



Figure 38: Crack in one of the propeller blades
Remnants of line were found in the crack.



Figure 39: More damage on another blade

3.2.5.5 Findings on the functioning of the CPP system

Service technicians from NORIS Automation GmbH, the manufacturer of the system's controller, assessed the functioning of the CPP system for the first time after the accident on 22 February 2018. With the exception of the error messages shown further above, no other electrical or mechanical errors were found. The system functioned in automatic and backup mode without any problems.

During the inspection of the ship on 12 March 2018, the parties involved (expert, police, BSU) checked the various functions of the CPP system again. The positioning times required by the system in normal operation and backup mode were also measured. The following values were noted manually while observing the pitch adjustment display:

- Normal operation using lever for pitch adjustment
 - pitch 'Zero (0%)' to 'Full Ahead (100%)' 1:33 minutes
 - pitch 'Full Ahead (100%)' to 'Zero (0%)' 0:44 minutes
 - pitch 'Zero (0%)' to 'Full Astern (100%)' 0:49 minutes
 - pitch 'Full Astern (100%)' to 'Zero (0%)' 0:28 minutes
- Backup control
 - pitch 'Zero (0%)' to 'Full Ahead (100%)' 00:21 minutes
 - pitch 'Full Ahead (100%)' to 'Zero (0%)' 00:23 minutes
 - pitch 'Zero (0%)' to 'Full Astern (100%)' 00:13 minutes
 - pitch 'Full Astern (100%)' to 'Zero (0%)' 00:12 minutes

The differences between the adjustment times of normal operating mode and backup mode are due to a delay stored in the control system, which also helps to keep the load on the main engine within the 100% limit²².

3.2.5.6 Findings on the propeller hub and hydraulic system

The error messages on the control system's display were discussed with technicians from NORIS Automation GmbH, the manufacturer of the CPP's control system, on 21 March 2018. The hydraulic power unit's tank was also surveyed after most of the oil had been drained. The tank's coating proved to be completely undamaged. Due to the oil's colouring, the bottom of the tank was not visible.

In the late afternoon of 21 March 2018, staff of SCHOTTEL had opened the propeller hub far enough for the valve body (Figure 40: 5) to be pulled out of the hub. It was found that the seal ring/O-ring at the front in the direction of travel (Figure 40: 39) was torn. In addition, it was noted that a support plate (Figure 40: 17) and a retaining ring²³ (Figure 40: 33) were not in their place.

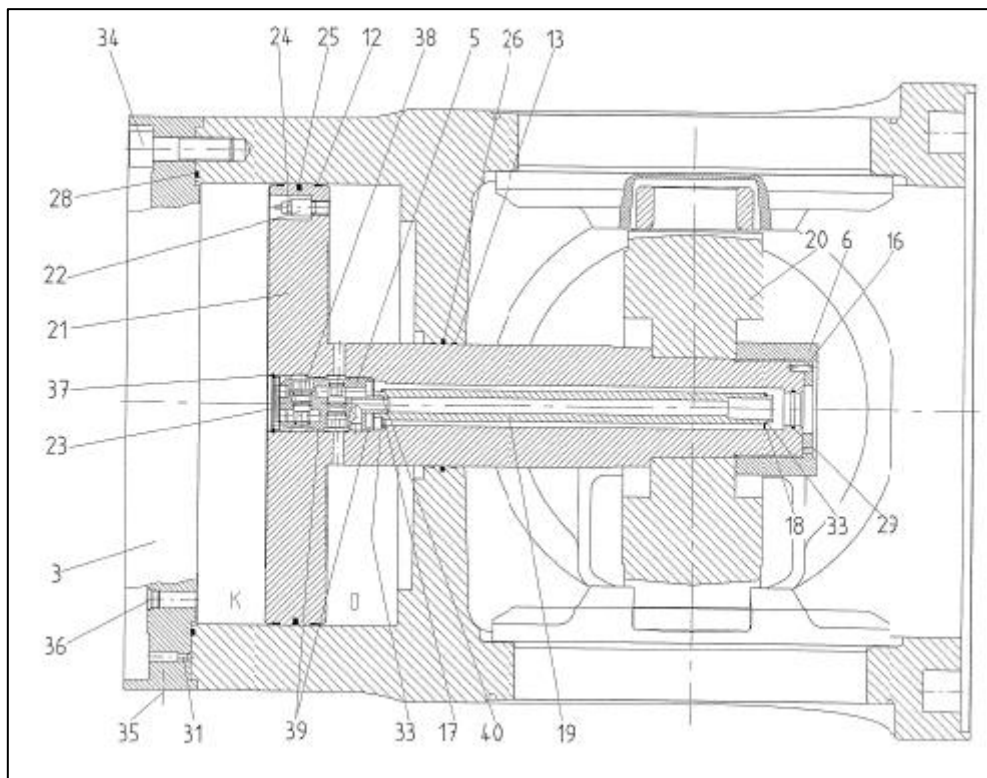

Figure 40: Propeller hub

5: valve body, 39: front and rear seal ring, 21: piston²⁴

²² NORISTAR 2000 – Propulsion Control System manual.

²³ In SCHOTTELS list of spare parts named as snap ring.

²⁴ Figure taken from SCHOTTEL's documentation for the SCP 141/4-XG CPP system.

When the CPP system was further dismantled in the shipyard, the service technician found fragments of the support plate in the system.



Figure 41: Location of the fragments shown in Figure 42²⁵

Parts of the support plate in the area of the hydraulic oil line connection are shown here.



Figure 42: Fragments of the support plate found²⁶

In the context of the discovery of the fragments, the bottom of the hydraulic tank was searched with a magnet. Metallic abrasion dust was discovered there.

²⁵ Figure from SCHOTTEL service report on the works between 21 and 27 March 2018.

²⁶ Ibid.

Due to the findings made on the day before, another survey on board was carried out on 22 March 2018. Particles were clearly visible at the bottom of the tank, which was now almost empty. In addition to metal particles, plastic particles were also found (Figures 43 and 44).



Figure 43: Deposits in the tank of the hydraulic power unit

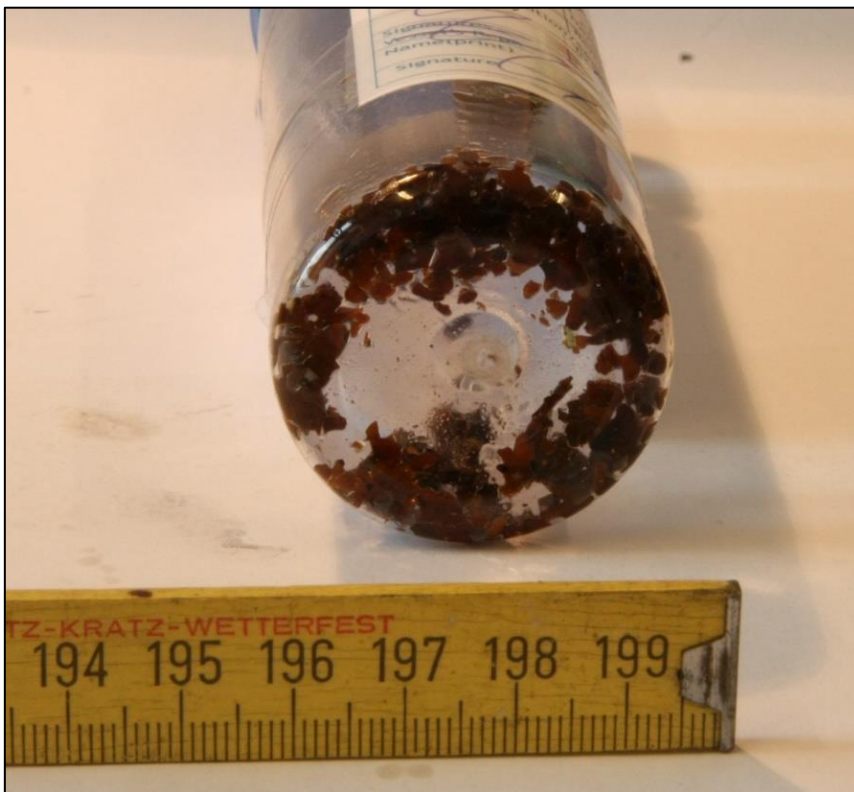

Figure 44: Sample of particles found in the tank

The following components were also presented to the BSU during the survey:

1. valve body with accumulated foreign body (Figure 45);
2. one torn seal ring belonging to the valve body; here the front (in the direction of travel) seal ring (Figure 48);
3. non-return valve with accumulated foreign body (Figure 49);
4. disc (Figure 40: 23);
5. circlip (Figure 40: 37).

The BSU secured all the above components, subjecting them to a closer inspection later on.

Re 1.: It was found that a metal foreign body was caught in the valve body and that there was damage in the form of a dent on the forward edge of the valve body. The foreign body was removed.

Re 2.: The torn seal ring had additional notches.

Re 3.: A metal foreign body was also removed from the non-return valve in the piping upstream of the oil cooler.

The objects at 4. and 5. did not exhibit any anomalies.



Figure 45: Valve body and removed foreign body (A)²⁷

²⁷ See Figure 40; here 5.

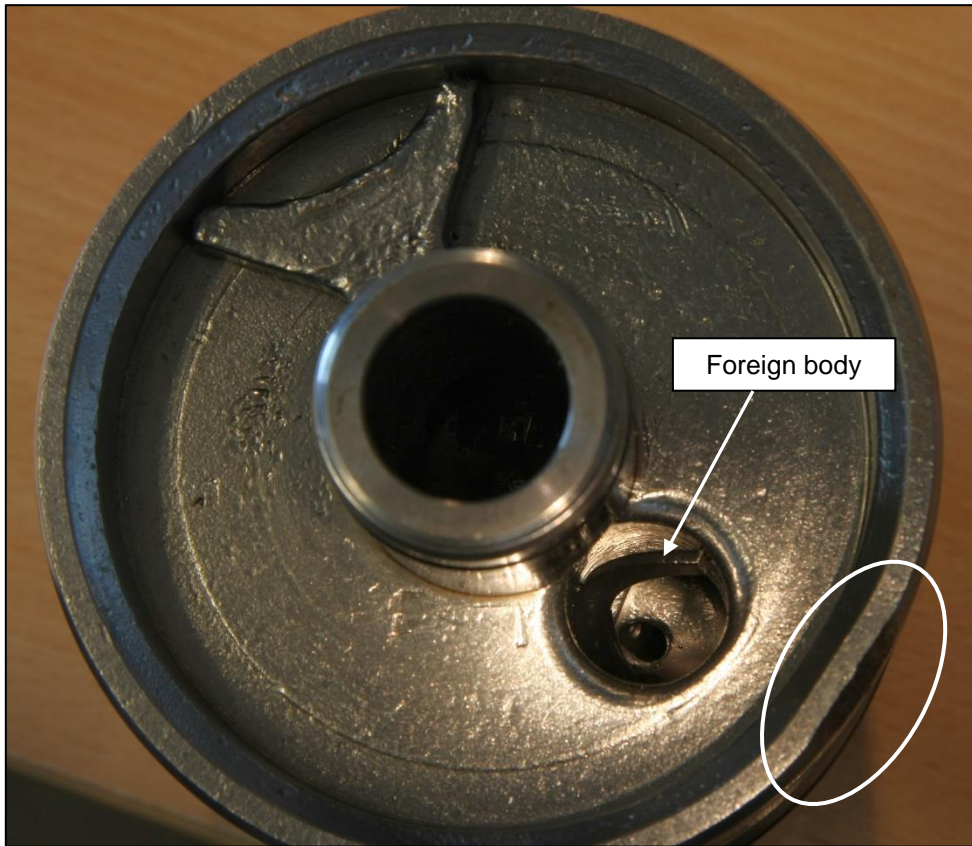

Figure 46: Valve body belonging to the hydraulic cylinder in the propeller hub
Top view with foreign body before removal and the damage in the form of a dent shown here.

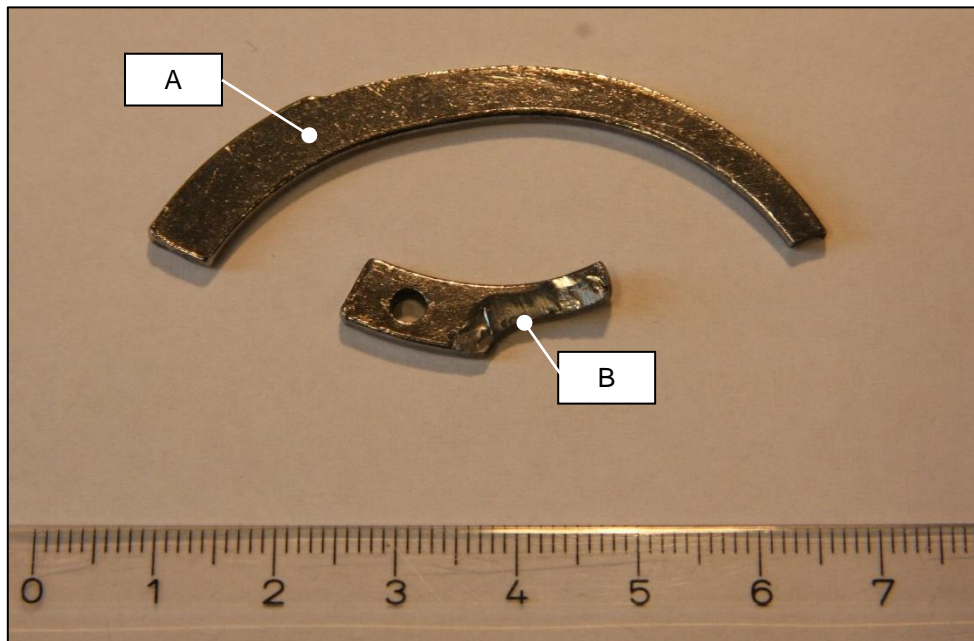

Figure 47: Removed foreign bodies
A: foreign body from the valve body; B: foreign body from the non-return valve



Figure 48: Torn seal ring with notches

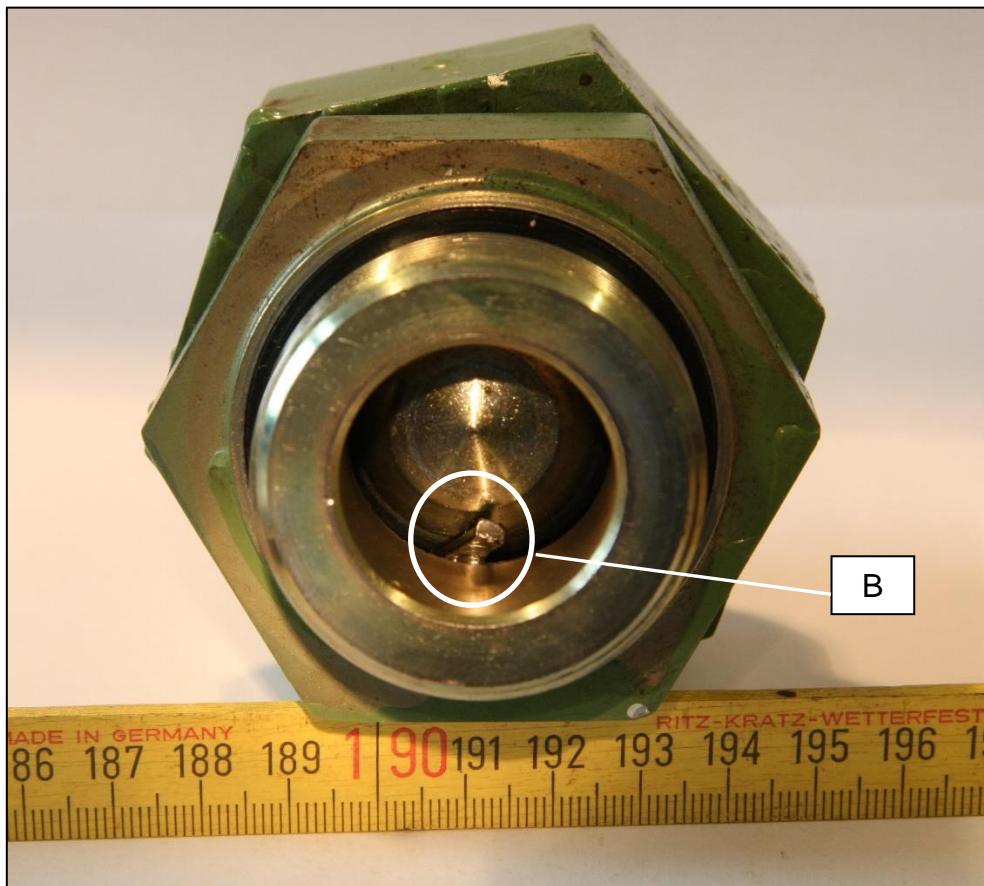

Figure 49: Non-return valve with foreign body (B)²⁸

²⁸ See Figure 51 for the position of the non-return valve.

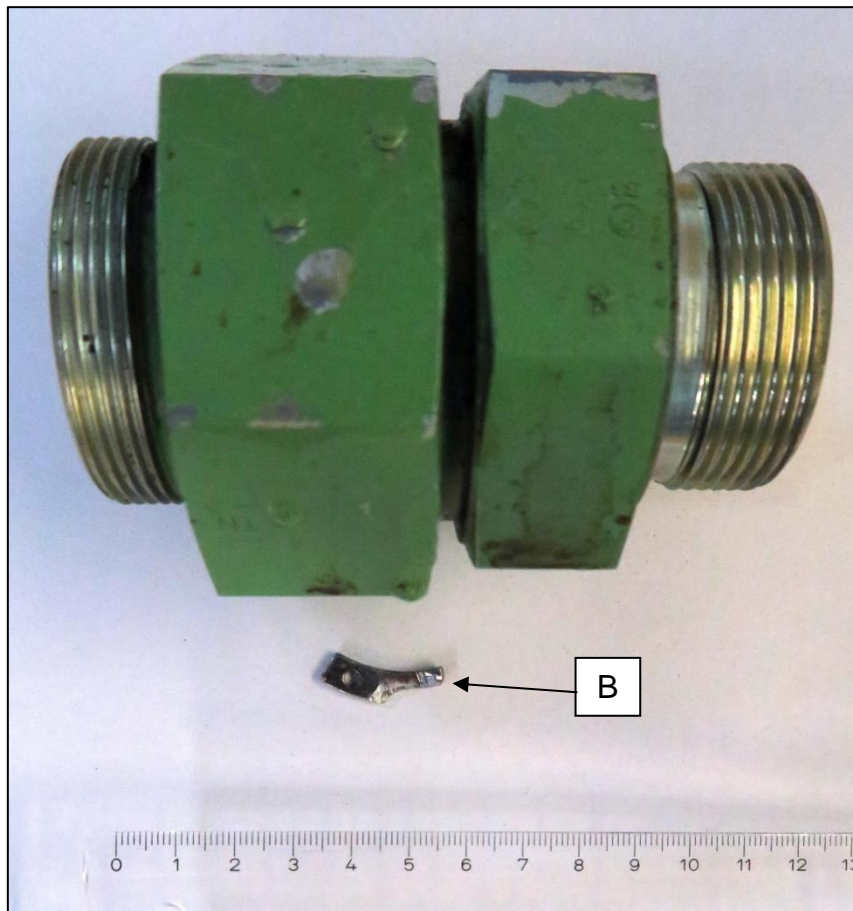

Figure 50: Non-return valve and removed foreign body

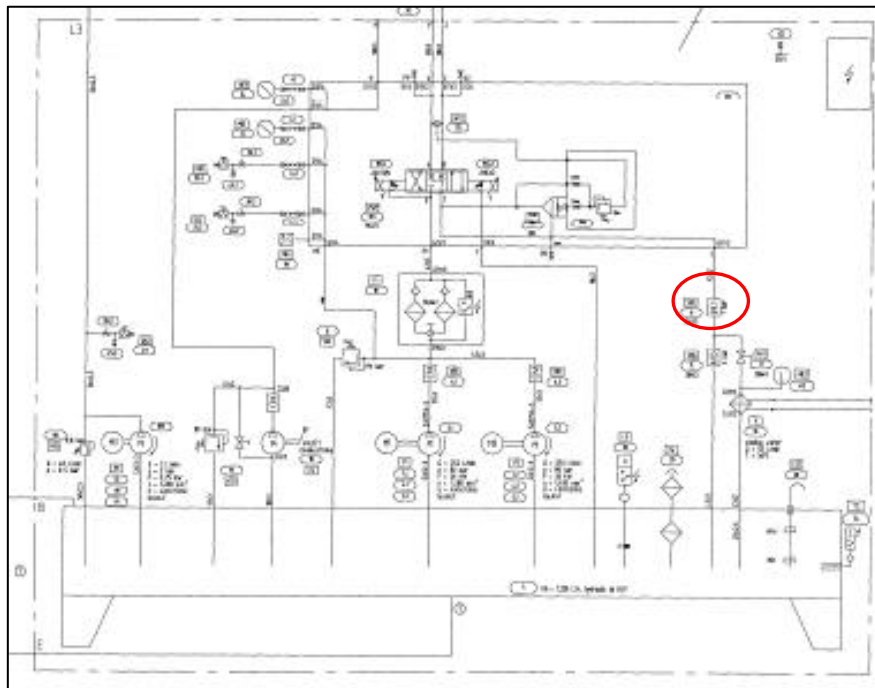

Figure 51: Extract from the diagram of the hydraulic system (see Figure 27)
Position of the non-return valve upstream of the oil cooler

The removed foreign bodies are parts of the retaining ring/circlip, the absence of which was detected during the dismantling of the valve body on 21 March 2018.

On 12 April 2018, the investigating police officers and the BSU were able to survey the disassembled CPP system in Wismar in one of the manufacturer's workshops, during which other damage to the system was presented. For example, there was substantial abrasion on the cover flange²⁹ which possibly not be related to the cause of the damage inside the propeller hub. The investigators believe this is the result of abrasion caused by the rope guard.



Figure 52: Material removal on cover flange
Original condition of the component marked in yellow.



Figure 53: Notch on the bearing plate

During the survey, SCHOTTEL employees expressed the opinion that contact between the propeller blades and a floating line or fishing net reportedly did not cause the breakage of the parts in the propeller hub. The energy required for this could reportedly

²⁹ Propeller hub cover facing forward in direction of travel.

only have been generated by contact with a solid object, i.e. a rock or floating container. The contact reportedly led to a sudden and substantial force being applied in a linear direction in the system. As a result, the broken component parts were reportedly also moved in the direction ahead and destroyed, as they are not designed for such loads.

3.2.5.7 Proportional valve

SCHOTTEL sent the proportional valve to Parker Hannifin GmbH & Co. KG for further dismantling and assessment. The report prepared there during the assessment was submitted to the BSU. It was established that the valve (type 4DP06 3E02F25003A1 G24 C1X) originated from an older production series of the manufacturer Denison.

It was found during the assessment that the piston had jammed in the housing. The control edge of the connection from A to T on the piston had been damaged by a foreign body, which was no longer in the valve. Scores had formed on the control edge. The jammed foreign body led to the failure, as the piston was no longer controllable.

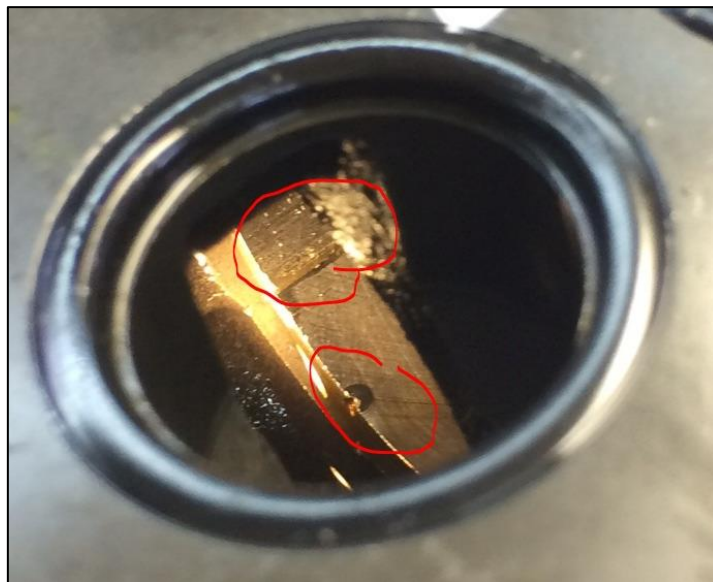

Figure 54: Damage to the control edge of the piston³⁰

³⁰ Figure from the Parker Hannifin GmbH & Co. KG report with markings inserted by the expert.

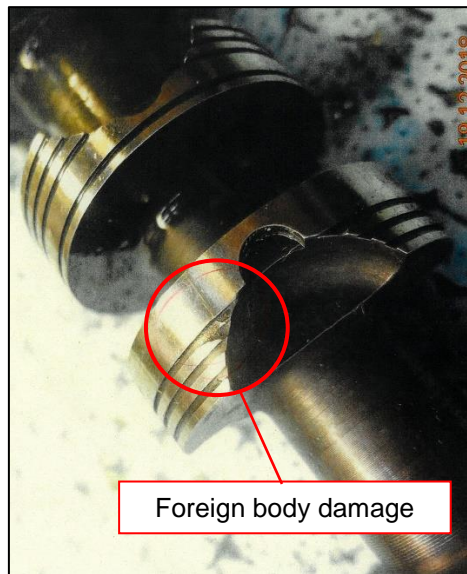

Figure 55: Damage to the piston of the proportional valve³¹

3.2.5.8 Shell-and-tube cooler for hydraulic oil

As part of the damage assessment and repair of the CPP system and hydraulics, Schlie Hydraulik Service GmbH dismantled, assessed, restored and flushed the hydraulic system in the AKACIA's engine room. During the assessment of the shell-and-tube cooler (oil cooler – see also Figure 27 for the position of the oil cooler in the hydraulic system), a foreign body was found inside the cooler. No other components, such as pumps or pressure limiters, exhibited any particular anomalies.

³¹ Figure from the report by the technical investigation team of WSP Hamburg.

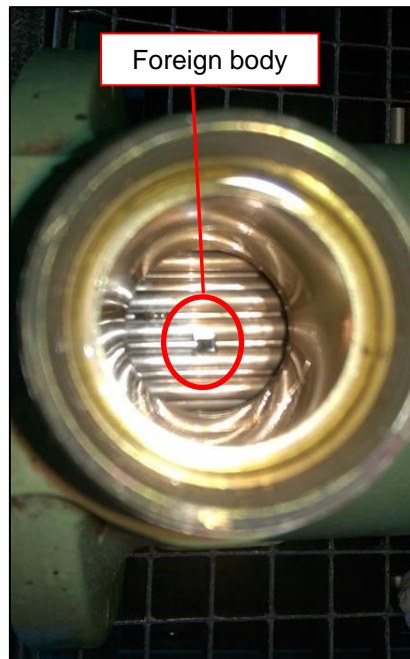

Figure 56: View into the shell-and-tube cooler³²



Figure 57: Identified foreign body³³

3.2.6 Engine alarm printer

As already discussed, the first engine alarm associated with the subsequent collision with the lock occurred at 0824 on 1 February 2018 (see Figure 31). It was defined in the printout as 'Remot. Contr. Fail. CPP ON'. According to the corrected time, the error occurred at 2350 ship's time on 19 February 2019.

In the period of the event, the main engine was operated at constant speed. The shaft-driven generator (60 Hz) supplied bow and stern thrusters. The on-board power supply was provided separately by the auxiliary diesel generators. The energy balance of the ship was not at risk. Due to the blocking of the proportional valve and the resulting pitch adjustment to "full ahead", the main engine was overloaded, as the propeller pitch

³² Figure from the Schlie Hydraulik Service GmbH report.

³³ Ibid.

could not be reduced due to the blockage and the constant speed of the main engine could not be maintained anymore. As a result of the speed drop, the frequency dropped and the shaft generator circuit breaker tripped, causing bow and stern thrusters to fail.

The shaft-driven generator breaker trip occurred at 23:51 (Figure 58) and was indicated in the log by a bow and stern thruster failure.

The ensuing alarms confirm the increased power consumption of the main engine. This was followed at 2351 by an alarm due to increased exhaust gas temperature at the measuring point behind the turbocharger, an alarm due to the resulting automatic reduction in the main engine's rated speed and alarms from cylinders 5 and 3 due to increased exhaust gas temperatures at their position. At 2352, cylinders 1, 2, 4, 7 and 6 followed with increased exhaust temperature. The alarms concerning the exhaust gas temperatures were already cancelled again by 2353. The system, i.e. the exhaust gas temperatures, had evidently returned to the normal range due to the automatic speed reduction.

The 'Remot. Contr. Fail. CPP' alarm was also cancelled again by 2353.³⁴

The printer recorded the 'Emerg. Stop – ME' alarm, i.e. main engine emergency stop, at 2354. At the same time, the bilge alarm was recorded in the bow thruster room, which the investigators believe was triggered by the ingress of water there after the allision with the lock gate.

³⁴ Shown with "- -" on the alarm printer printout. See also Figure 58.

LT-Cool Wat Temp	ME		
0153	31.01/19:21	AL1	--
Lub Oil Temp	ME		
0174	31.01/19:21	AL1	--
LT-Cool Wat Temp	ME		
0117	31.01/19:22	AL1	--
Autom Eng Stop			
01A4	01.02/08:24	AL1	ON
Remot Contr Fail	CPP		
03A6	01.02/08:25	AL1	ON
Bow Thruster Fail			
03A8	01.02/08:25	AL1	ON
Stern Thruster Fail			
0132	01.02/08:25	AL1	ON
Exh Gas T -Aft IC			
0118	01.02/08:25	AL1	ON
Autom Eng Reduce			
0125	01.02/08:25	AL1	ON
Exh Gas Temp.-Cyl 5			
0133	01.02/08:25	AL1	ON
Exh Gas-Cyl Max			
0123	01.02/08:25	AL1	ON
Exh Gas Temp.-Cyl 3			
0121	01.02/08:25	AL1	ON
Exh Gas Temp.-Cyl 1			
0122	01.02/08:25	AL1	ON
Exh Gas Temp.-Cyl 2			
0124	01.02/08:26	AL1	ON
Exh Gas Temp.-Cyl 4			
0127	01.02/08:26	AL1	ON
Exh Gas Temp.-Cyl 7			
0125	01.02/08:26	AL1	ON
Exh Gas Temp.-Cyl 6			
0126	01.02/08:27	AL1	--
Exh Gas Temp.-Cyl 6			
0127	01.02/08:27	AL1	--
Exh Gas Temp.-Cyl 7			
0121	01.02/08:27	AL1	--
Exh Gas Temp.-Cyl 1			
0125	01.02/08:27	AL1	--
Exh Gas Temp.-Cyl 5			
01A4	01.02/08:27	AL1	--
Remot Contr Fail	CPP		
0123	01.02/08:27	AL1	--
Exh Gas Temp.-Cyl 3			
0124	01.02/08:27	AL1	--
Exh Gas Temp.-Cyl 4			
0122	01.02/08:27	AL1	--
Exh Gas Temp.-Cyl 2			
0133	01.02/08:27	AL1	--
Exh Gas-Cyl Max			
0132	01.02/08:27	AL1	--
Exh Gas T -Aft IC			
0116	01.02/08:28	AL1	ON
Emerg Stop - ME			
0398	01.02/08:28	AL1	ON
Bilge-Bow Thruster R			
0118	01.02/08:28	AL1	--
Autom Eng Reduce			
03A8	01.02/08:32	AL1	--
Stern Thruster Fail			
03A6	01.02/08:32	AL1	--
Bow Thruster Fail			
0116	01.02/08:33	AL1	--
Emerg Stop - ME			
0117	01.02/08:35	AL1	ON
Autom Eng Stop			

Figure 58: Extract from the printout of the ECR's alarm printer

The alarms associated with the CPP system and main engine emergency stop are marked in red.

3.2.6.1 Statements of the engine room crew

In his statement, the CE pointed out that in addition to the shaft generator, the two auxiliary diesel engines were used to generate electricity while transiting the canal. At about 2345, he and the 2nd Eng. were together in the ECR. At this point, he noticed that the load on the main engine was increasing. The main engine's turbocharger started to surge, while the pitch was approaching 100%. He and the 2nd Eng. immediately went to the engine room to establish the cause. Meanwhile, various alarms were triggered in the ECR. Among them was also the alarm on the CPP system's display, which indicated the 'remote control failure cpp'. In contrast with the usual position for transiting canals of about 35%, the pitch of the propeller blades stood at 100%. The CE said in his statement that he informed the master by phone that the load on the main engine had increased, thereby reducing the revolutions of the main engine. Shortly afterwards, the master instructed him to initiate a main engine emergency stop and he pressed the corresponding button immediately. He then instructed the 2nd Eng. to check the engine room. He instructed the fitter, who was also on duty, to check the funnel because – according to the statement of the 2nd Eng.– there was also an alarm for a fire in the exhaust gas boiler³⁵. The CE went to the bow thruster because an alarm had also been triggered there³⁶. The CE stated that there had been no problems with the CPP system in the past and that the crew had carried out all the necessary servicing.

The material points of the 2nd Eng.'s statement were similar.

3.2.7 Emergency anchoring manoeuvre

The AKACIA's fore section was manned by three people ready for making fast in the lock. An able seafarer deck who was qualified to operate the anchor gear according to Regulation II/5 STCW led this group. The second crew member, who was also employed as an able seafarer deck, was qualified as a watchkeeping officer³⁷ according to Regulations II/1 and IV/2. The third crew member was an oiler.

The head of the group also gave a statement to the BSU, according to which he has been working as an able seafarer deck since 1999. His present contract on the AKACIA started on 26 October 2017.

He made the following statements regarding events on the forecandle: After the master had instructed the group to go to the forecandle, they went there and started preparing the lines. A few minutes later, the master gave instructions to drop both anchors. The

³⁵ The alarm log (Figure 58) gives no indication of a fire in the exhaust gas boiler.

³⁶ The investigators believe that this refers to the bilge alarm in the bow thruster room at 2354 (1 February at 0828) (Figure 58).

³⁷ Officer in Charge of a Navigational Watch.

anchors were prepared for an emergency anchoring manoeuvre in the usual manner, i.e. the chain stoppers were released and the anchor windlass was uncoupled. In each case, the band brakes were released by an able seafarer deck without any problems, allowing both anchors to drop at the same time. The brakes were set again after two shots of chain cable were paid out. The group's leader checked the chains and found they were both tight and pointing aft.

The visual check of the windlasses following the accident delivered no further information. Both the anchors with corresponding gear looked as if they were maintained.

The master's order to drop the anchor was issued at 235158. It was repeated shortly after, at 235209, as confirmation was requested on the forecastle.

The audio recording on the VDR only contains only one call from the forecastle to the bridge at 235312, which was made after the master's first order to drop the anchor. The content of the message is inaudible. The master replies at 235314: "Let go. Fall the ... fall the anchors."³⁸ However, in view of the impending allision with the lock, the investigators are not sure whether this order corresponds with the information from the forecastle.

On the AKACIA, one length of chain cable corresponds to 27.5 m. According to the person responsible on the forecastle, two lengths of chain cable (or 55 m) were paid out. Accordingly, both anchors were still in the area of the hull after being lowered and dragged along. After getting stuck in the lock gate, both anchors were inside the lock. Therefore, an anchor chain or anchor did not obstruct the inner lock gate.

³⁸ See also footnote 14.

4 ANALYSIS

4.1 Failure of the CPP system

During the interviews, the crew on board the AKACIA could not remember any event that might have caused damage to the propeller blades and other parts of the propeller hub. No damage to the propeller blades was noticed during the ship's last dry docking in January 2017.

The manufacturer of the CPP system attributes the damage to significant contact with a solid object due to the damage pattern.

During the surveys in the course of the investigation and gradual dismantling of the system, other damage was discovered in addition to that on the propeller blades. For example, fragments of a retaining ring were found in the valve body and in a non-return valve upstream of the oil cooler and in the actual oil cooler. In addition, larger fragments of a support plate were found in the area of the adjoining pipelines after the valve body was dismantled. The retaining ring and support plate were not among the system's moving parts. Neither were designed to absorb greater forces acting in the longitudinal direction of the ship. Therefore, the harmful event destroyed them to such an extent that their fragments could enter the system.

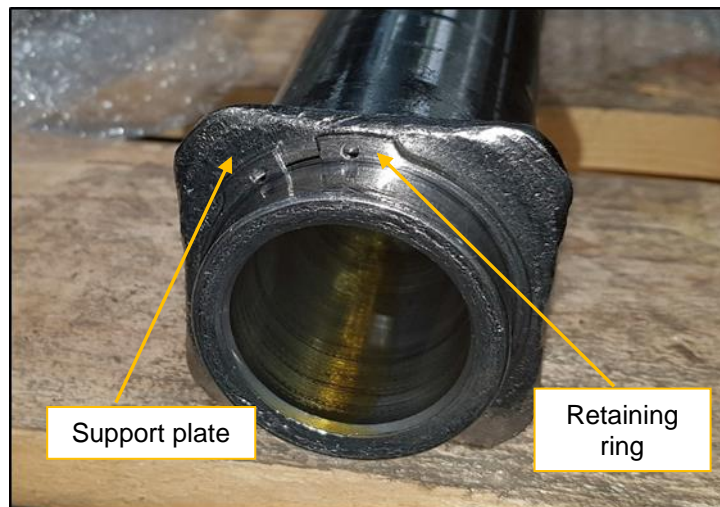

Figure 59: Hydraulic oil pipe with support plate and circlip

An undamaged section of the hydraulic pipe is shown here.

Fragments and particles could enter the proportional valve unhindered from the direction of the propeller hub, since the hydraulic oil is only filtered when sucked from the tank of the hydraulic unit. According to the manufacturer, filtering is also technically possible for the lines leading from the propeller hub to the proportional valve. However, since this requires higher pressures in the system or a higher pumping capacity, which

increases the costs of the system, this design is only used in military vessels. The design of the system met the technical requirements.

The size of the metal parts found in the non-return valve upstream of the oil cooler and in the actual oil cooler was such that they were able to pass through the hydraulic system from the propeller hub to the hydraulic power unit. The time required to pass through the hydraulic system is uncertain. Consequently, conclusions as to the triggering event cannot be drawn.

Smaller metal and plastic parts passed through the entire system from the propeller hub through the proportional valve to the tank probably without affecting the proportional valve. However, the investigators do believe that either the fragment found in the non-return valve or in the oil cooler resulted in a blockage of the proportional valve. Corresponding damage was found in the proportional valve when it was dismantled. The investigators also believe that the blockage took place when the pitch adjustment was made in the direction ahead, as this was the only way to make a pitch adjustment of 100% and above. The damage to the piston at the control edge from A to T found when the proportional valve was dismantled is an indication of this (see Figures 54 and 55). During the previous adjustment of the piston for the astern manoeuvre to the right a fragment seems to have been able to settle there (Figure 60). This fragment then blocked the piston during the subsequent adjustment to the left (pitch adjustment in the direction ahead), as shown in Figure 61. The usual deactivation of the hydraulic oil flow by moving the piston to the middle position when the required pitch is reached was prevented by the blockage. This allowed the pitch to rise to the maximum position because the oil flow in the direction ahead was not interrupted.

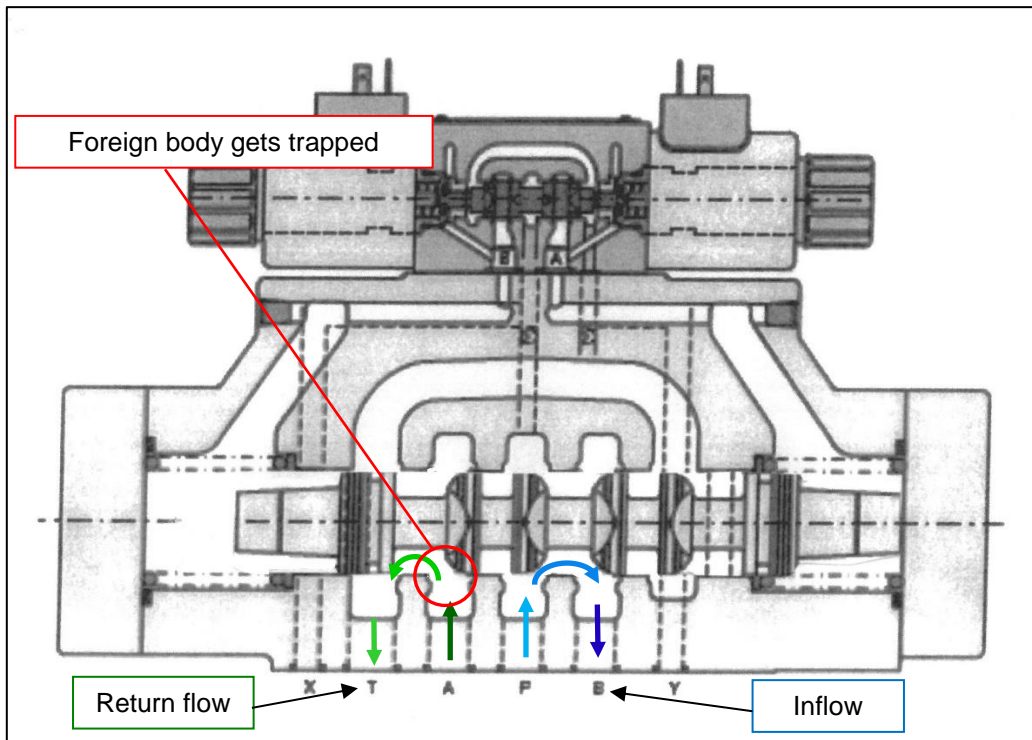

Figure 60: 4/3-way proportional valve

Piston for pitch adjustment in the direction astern shifted to the right

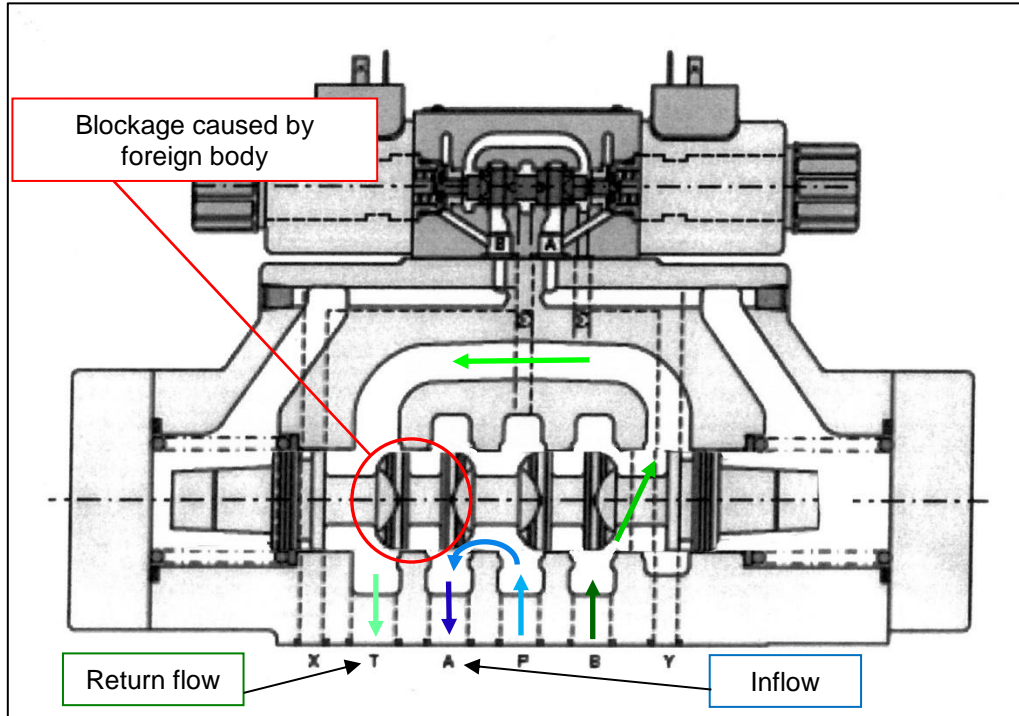

Figure 61: 4/3-way proportional valve

Piston for pitch adjustment in the direction ahead shifted to the left here. This causes trapped foreign body to block the piston. **P** – constant oil flow from pump through filter to proportional valve. **A** – oil flow through OD-box to propeller hub to set hydraulic piston in the direction ahead. **B** – return flow of hydraulic oil from hydraulic piston on the side not under pressure. **T** – return flow of hydraulic oil through oil cooler to tank.

The first 'error pitch/pitch controller' error message at 235042 indicated that the piston setting did not correspond to the pitch adjustment (or the non-deactivation of the hydraulic oil flow). Exceeding the 100% pitch then triggered the next error message at 235101: '2. actual pitch signal back-up-system'.

The investigators believe that the first CPP system error message at 235042 was associated with the first alarm recorded by the engine's alarm printer at 2350: 'Remot. Contr. Fail. CPP ON'.

The investigators are of the opinion that the 'error pitch/pitch controller' error message deactivated when the master switched to backup control at 235150. Deactivation of the message due to the elimination of the fault is considered less likely, as the master reported on the activation of the backup control. Moreover, the engine's alarm log had not recorded the alarm as cancelled at this point. On the other hand, the system reactivated the error message several seconds later at 235215. The investigators believe there was a connection with the master's actions here, too. After the master evidently quickly recognised that the system could be switched to backup mode but that pressing the PITCH ASTERN button did not affect the pitch, he switched back to normal operating mode. This caused the still associated alarm to be displayed again.

The '2. actual pitch signal back-up-system' error message deactivated at 235255. Since there had been no malfunctions previously with regard to controlling the CPP system and no anomalies could be found there after the accident, it is highly likely that the proportional valve blockage that caused the pitch to reach 110% no longer existed. The pitch had therefore returned to a value of $\leq 100\%$ at that point in time.

The first CPP system error to occur ('error pitch/pitch controller') deactivated 11 seconds later at 235306. This event was also recorded by the engine's alarm log (2353: 'Remot. Contr. Fail. CPP - -'). The investigators believe, this could be associated with the previously discussed deactivation of the '2. actual pitch signal back-up-system' error. Assuming that the original error no longer existed, the system responded again and the pitch of the propeller had returned to a range which was within the tolerance between actual and setpoint. When the tolerance range was reached, the error message went out. Thus there must not have been a match between actual and setpoint value.

The actual position of the control lever at this point in time is unknown due to missing data. Also the evaluation of the recording of the audio data of the voyage data recorder until the end of the recording did not give any clues about the position of the control lever or the indications of the pitch.

On the other hand, the cancellation of all alarms associated with the actual main engine emergency stop (alarm log entry at 2354) is also conceivable. This is due to the fact that the alarms recorded by the printer do not have an entry accurate to the nearest second. Therefore, a margin of one minute exists here. However, the investigators consider this less likely, as the time between the '2. actual pitch signal back-up-system' error, deactivated at 235255, and this alarm at 2354 is too long.

On the assumption, there is a connection between the deactivation of the '2. actual pitch signal back-up-system' and 'error pitch/pitch controller' error messages, the investigators assume that the system was ready for operation again at 235306. However, this circumstance was not apparent to the master on the bridge due to missing indicators.

4.2 Course of the voyage

The AKACIA's voyage passed uneventfully up until the first alarm. The identified violations of the permitted speed in certain areas of the NOK prior to the passage of the bridges at Holtenau did not play any role in the event leading up to the marine casualty.

The AKACIA's bridge and engine room were sufficiently manned by experienced crew members. The qualifications presented indicated that two of the crew members on the forecastle were suitably qualified for the tasks to be carried out in connection with the anchor gear.

The pilot, who the master had briefed at the beginning of his advisory activities, and the canal helmsman had been working on the NOK for many years and were familiar with the type of ship.

The investigators found no evidence to suggest that particular circumstances or fatigue played a role in the accident.

In the opinion of the investigators, the first alarm was issued when the pilot set the CPP system's control lever to ahead to assist with steering onto the course required for approaching the lock by means of an appropriate slipstream at the rudder. No evidence could be found for the second manoeuvre astern (recalled by the pilot) after the manoeuvre ahead to assist with steering onto the course. Rather, the time between the aforementioned manoeuvre ahead and the first alarm, as well as the assumed course of the proportional valve blockage are indicative of only a manoeuvre astern.

After the audible alarm started at 235042, the pilot quickly realised that the ship was increasing in speed and it was not possible to make any adjustments using the CPP system's control lever. He brought this to the master's attention with ever-increasing urgency. Shortly afterwards, he notified the traffic control station responsible for this section of the NOK.

The master initially attempted to regain control by operating the control lever. He evidently also considered a main engine emergency stop (see Section 3.2.3.1, 235126). Since it was not possible to regain control using the control lever, the investigators believe that the master switched to backup mode at 235150. The switching was signalled by lighting up of the indicator lamp.

On the advice of the pilot, the master ordered that both anchors be dropped at 235158. He confirmed this order at 235209 following a request from the forward manoeuvring station.

It was not possible to have any effect on the pitch adjustment in backup mode, either, although the operational capability was indicated by the system. The investigators assume that the master therefore switched back to normal operating mode at 235215. The investigators also assume that the phone call with the CE, in which the latter reported on the excessive load on the main engine and the resulting reduction in speed, took place simultaneously. The captain ended the conversation by saying, "Okay, emergency stop." (235215). This was obviously overheard or not implemented by the engine crew. It is also possible, however, that the telephone conversation had already ended and the captain made the statement within a consideration, as happened at 235126. The rapid sequence of events (235209 - confirmation of dropping the anchors, 235210 - beginning of the conversation with the CE, 235215 - switching of the controllable pitch propeller control system from backup control to normal control), which claimed the captain, would speak for this.

The speed of the ship was now 10.1 kts and the distance to the subsequent point of impact about 2.7 cbl.

At 235222, a member of the bridge management team briefly sounded the tyfon. The pilot warned the Vessel Traffic Service shortly afterwards, stating the situation as out of control.

At 235248, the master instructed the group on the forecastle to drop the anchors again.

At 235314, after receiving a radio call from the forecastle (235311), the captain said, "Let go. Fall the... fall the anchors." The content of this call was incomprehensible in the VDR recording. It therefore remains open whether it was a new request or rather a confirmation. The BSU assumes that the anchors were dropped immediately after the confirmation given by the captain (235209).

As stated in Section 4.1, the cancellation of the CPP system alarms and corresponding entry in the main engine's alarm log suggest to the investigators that the electronic remote control of CPP system was operational again at 235306. At this point, the speed

of the ship was about 9.8 kts and the distance to the gate about 1.2 cbl. It cannot be determined with certainty whether the controllable-pitch propeller system was completely mechanically available again from this time on.

The master repeated his instruction to implement a main engine emergency stop at 235356. This could correspond with the account of the CE and 2nd Eng., who explained in their statement that after the first phone call with the master they received another call in which the master ordered an emergency stop. The engine crew immediately complied with this request.

The allision between the AKACIA and the Neue Südschleuse lock's seaward gate in Kiel-Holtenau occurred at 235402.

The investigators assume that the control of the CPP system was on the bridge during the entire period.

4.3 Chronological overview of the error messages and alarms

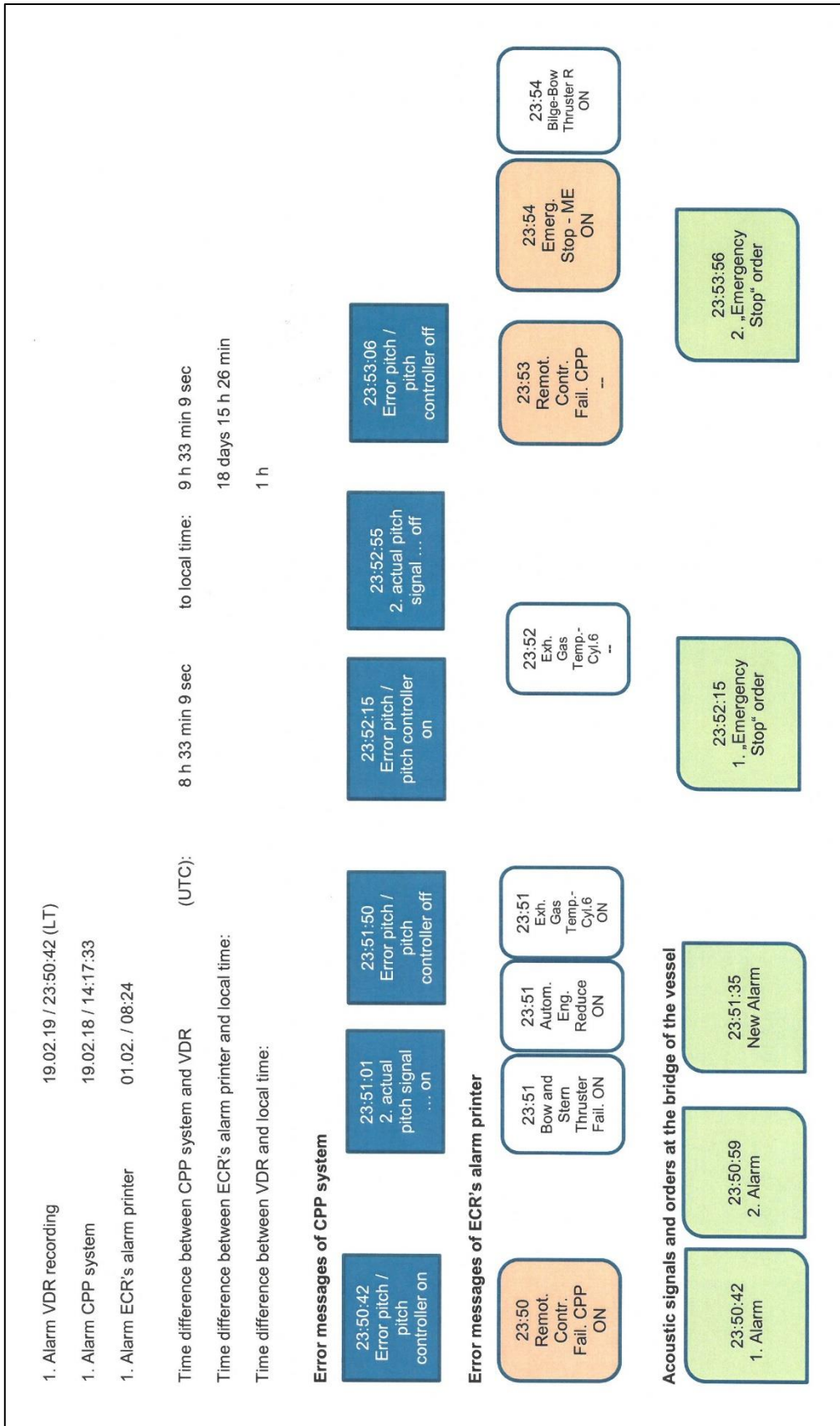

Figure 62: Overview of error messages and alarms

In the context of the investigation, it became apparent that the system times considered here differed from the ship's time. In particular, the difference in the time of the engine's alarm printer (18 days 15 hours 26 minutes) is remarkable.

Within the scope of the investigation, the checklists for making the bridge and the engine room, respectively, ready for departure and arrival of the vessel were revised. In doing so, it was noticed that only the checklist for making ready the bridge for departure comprised an item for the comparison and synchronisation of the clocks.

4.3.1 Manoeuvring characteristics

The following explanation is based on the manoeuvring characteristics of the vessel.

Ignoring the fact, that neither an ASTERN FULL manoeuvre nor another adjustment of pitch would have been possible from 235042 on, due to the failure of the CPP, the following data could have been used for an ASTERN FULL manoeuvre.

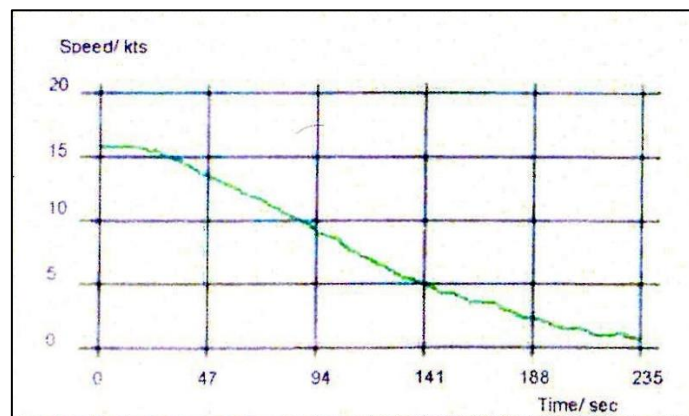

Figure 63: Speed-time-diagram for AHEAD FULL SEA to ASTERN FULL

Speed at Start:	15,70 kts
Speed at End:	0.0 kts
Speed Step:	Astern Full
Initial Heading:	90,7°
Final Heading:	183,2°
Time to Stop:	234s
Total Distance:	938,1m / 5,1 cbl / 6,7 S.L.

Figure 64: Data for AHEAD FULL SEA to ASTERN FULL³⁹

At the time of the CCP system's failure at 235042, the distance of the forecastle to the closed lock gate amounted to approximately 4.9 cable lengths. Due to the lower speed and mass of the vessel as well as the shallow water effect, the stop distance would

³⁹ At the point in time of the sea trials, the draft was 8.5 m ahead and 8.7 m aft.

have presumably sufficed at an ASTERN FULL manoeuvre (only theoretically possible).

The question as to whether the stop distance would have sufficed, if an emergency stop of the main engine had been initiated immediately at the time in question, must remain open. The values for the “AHEAD FULL to STOP manoeuvre” were available for assessing the emergency stop of the main engine and the stop distance resulting from that. However, this trial was completed in an unloaded condition with a speed of 18 kts. The data sheet available does not allow a conclusion as to whether an emergency stop of the main engine carried out earlier would have prevented or at least weakened the collision. This is particularly due to the deviating loading and the test conditions. Here, the propeller rotating in zero-position probably resulted in a stronger and the open water presumably in a lower time delay.

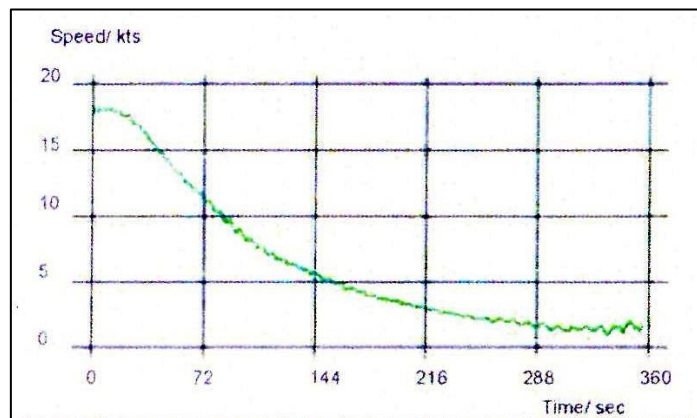

Figure 65: Speed-time-diagram for AHEAD FULL SEA to STOP

Speed at Start:	18,00 kts
Speed at End:	1,90 kts
Speed Step:	Stop
Initial Heading:	310,5°
Final Heading:	247°
Time to Stop:	357s
Total Distance:	1170,8m / 6,3 cbl / 8,4 S.L.

Figure 66: Data for AHEAD FULL SEA to STOP⁴⁰

⁴⁰ At the point in time of the sea trials, the draft was 4.6 m ahead and 5.7 m aft.

5 CONCLUSIONS

5.1 CPP system

Damage was found on the propeller blades and in the hub of the CPP system during the investigation. This damage was caused by contact with an unknown solid object at an unknown time. In the view of the BSU's investigators, this damage was also responsible for the failure of the CPP system at the beginning of the event discussed in this report. At least one of the fragments produced during the primary harmful event had reached the proportional valve by the time the ship approached the lock. In the proportional valve, this fragment then caused the piston to be blocked in the position 'adjustment of pitch in the direction ahead'. As a result, the hydraulic oil flow could not be interrupted when the position required by the pilot was reached, causing the propeller blades to adjust to the maximum (110%) in the direction ahead.

Irrespective of whether the crew was aware of the causal event, the timing of the occurrence of the blockage was or would not have been predictable. This is all the more true as the extent of the damage was unknown in any case. The crew was therefore completely surprised by the event.

The BSU's investigators believe that the crew had no way of influencing the CPP system to remove this blockage, as the blockage of the proportional valve was neither removed by switching to backup mode nor could have been removed by switching to emergency operation. Having said that, the investigators assume that the crew did not switch to emergency operation. Even switching over to the engine room would not have changed the situation. In addition, the cause of the problem was difficult or impossible for the crew to identify. The investigators believe that the removal of the blockage happened by chance, possibly in connection with the high oil pressure in the system, which resulted in the fragment being flushed out after a short time.

5.2 Course of the voyage

The vessel's command and the pilot sailed the AKACIA through the Kiel Canal in the usual way, which is generally not objectionable. The pilot carried out the astern manoeuvre requested before entering the lock in a timely manner. The notification required afterwards remained undone due to the unfolding events subsequently.

The investigators are of the opinion that the course of events, as perceived by them, was responded to appropriately by the crew and the pilots. The ship's command tried out the two obvious ways of influencing the CPP's control system, thus usual actuation of the pitch controller and operation of the backup control. Both did not lead to a change in the condition, although they obviously worked or no fault in the electrical connection could be detected. It could not be determined with certainty whether the captain telephoned at 23:52:15 to request the initiation of an emergency stop of the main

engine by the engine crew or whether it was more a matter of deliberation. It also remains unclear why the emergency stop was not triggered self-acting by the master at the bridge console. It is also possible that the CE was distracted by the number of alarms at the end of the telephone call and thus did not hear the master's instruction. Just what effect an emergency stop of the main engine at 235215 would have had in terms of the scale of the damage to the gate remains questionable. At this point, there were still some 2.6 cbl to cover and the speed of the ship was 10.1 kts. Since the manoeuvre characteristics gained from trial runs concerning this topic are not meaningful, all deliberations thereunto would be speculative

The emergency stop initiated at 2354 after the master repeated his instructions by phone had no effect on the course of the accident.

It was not possible to determine the time at which the anchors were dropped during the emergency anchoring manoeuvre with certainty in the course of the investigation. The anchors may have been dropped while the bow of the ship was still at the leading jetty of the lock. All in all, the investigators believe that the effect of the anchors on the speed reduction was rather minor. Rather, the investigators attribute the reduction in speed before the impact to braking hydrodynamic effects during the rapid entry of the ship into the relatively narrow lock chamber.

5.3 Times

In the course of the investigation, it was established that crucial times in the engine control room significantly deviated from the actual ships time and UTC, respectively. The investigators consider this a safety risk. Furthermore, it was ascertained that the checklist for making the engine room ready for the sea voyage did not comprise a test item for the alignment and synchronisation of the clocks, respectively.

6 Action taken

In April 2018, the vessels owner's legal counsel advised the BSU that the vessels owner prepared a Non Conformity Note with regard to the time deviations ascertained. This Non Conformity Note includes the instruction to synchronize the times in the engine room area to UTC in order take remedial action. Moreover, a regular check, especially after blackouts, is requested. In addition, compliance with the checklists for making ready the ship for the sea voyage is pointed out.

The shipping company revised the Safety Management Manual as part of the investigation of the accident and included the adjustment and adjustment of the clocks in the chapter on the measures to be taken in preparation for departure. In addition, the checklist for making the ship ready for departure was adapted accordingly.

The shipping company also announced that it has included drills for emergency operation of the controllable pitch propeller system in the "Annual Drill and Training Plan" within the Safety Management Manual and that these drills are now carried out quarterly for all engineers.

The Federal Bureau of Maritime Casualty Investigation therefore refrains from issuing a safety recommendation on these points. There is no need for further safety recommendations.

7 SOURCES

- Investigations of the WSP (Kiel District) and the technical investigation team of WSP 511 in Hamburg
- File of the public prosecutor's office in Kiel dated 3 May 2019
- Written statements of the ship's command, the engineers on duty and the person in charge at the forward manoeuvring station
- Witness testimony of the pilot and the canal helmsmen
- Navigational charts and ship particulars, BSH
- Recordings by the ship's VDR
- Documents and service reports from SCHOTTEL-Schiffsmaschinen GmbH (CPP system manufacturer) and NORIS Automation GmbH (CPP control system manufacturer). Additional service reports from Schlie Hydraulik Service GmbH and Parker Hannifin GmbH & Co. KG.